



# CLEMSON UNIVERSITY



## SITE DESIGN GUIDELINES

*a vocabulary for Clemson's sense of place*



PEDESTRIAN VEHICULAR BICYCLE VEGETATION FURNISHINGS LIGHTING SIGNAGE PAVING SITEWORK PARKING

<b>Section One</b>	<b>Introduction</b> .....	1
<b>Section Two</b>	<b>Pedestrian Systems</b>	
	2.1 Pedestrian Nodes .....	2
	2.2 Guidelines .....	3
	2.3 Pedestrian Paths .....	6
	2.4 Road Intersections .....	9
	2.5 Steps .....	11
	2.6 Outdoor Ramps .....	12
	2.7 Handrails .....	14
	2.8 Guardrails .....	15
<b>Section Three</b>	<b>Vehicular Systems</b>	
	3.1 Guidelines .....	16
	3.2 Road Hierarchy and Character .....	16
	3.3 Landscaping .....	17
	3.4 Building and Parking Setbacks .....	19
	3.5 Utility Easements .....	20
	3.6 Visibility Triangles .....	20
	3.7 Pedestrians .....	20
	3.8 Bicycles .....	21
	3.9 Parking Access and Road Widths .....	21
	3.10 Transit Stops .....	22
	3.11 Procedures .....	22
	3.12 Road Guidelines Graphics .....	23
	3.13 Road Setbacks and Widths Graphics .....	24
	Campus Road Hierarchy Map .....	25
<b>Section Four</b>	<b>Bicycle Systems</b>	
	4.1 Shared Roadways .....	26
	4.2 Bike Lanes .....	27
	4.3 Shared Use Paths .....	27
	4.4 Bicycle Parking Areas .....	28
	4.5 Bicycle Storage Areas .....	29
	4.6 Bicycle Signage .....	30
	4.7 References .....	31

<b>Section Five</b>	<b>Vegetation Systems</b>	
	5.1 Landscape Character .....	32
	5.2 Guidelines .....	33
	5.3 Uses .....	34
	5.4 Procedures .....	36
	5.5 Maintenance .....	36
	5.6 Plant Lists .....	37
<b>Section Six</b>	<b>Site Furnishings</b>	
	6.1 Guidelines .....	38
	6.2 Benches .....	38
	6.3 Trash Receptacles .....	39
	6.4 Mailboxes and Book Drop Containers .....	40
	6.5 Procedures .....	40
<b>Section Seven</b>	<b>Site Lighting</b>	
	7.1 Guidelines .....	41
	7.2 Lighting Fixtures .....	41
	7.3 Setbacks .....	42
	7.4 Illuminance Values .....	42
	7.5 Uniformity .....	43
	7.6 Spacing .....	44
	7.7 Procedures .....	44
<b>Section Eight</b>	<b>Signage</b>	
	8.1 Sign Guidelines .....	45
	8.2 Sign Classifications .....	45
	8.3 Procedures .....	46
<b>Section Nine</b>	<b>Paving</b>	
	9.1 Paving Characteristics .....	47

<b>Section Ten</b>	<b>Site Work</b>	
	10.1 Guidelines .....	49
	10.2 Soil Erosion and Sedimentation Control .....	50
	10.3 Slope Design and Treatment .....	52
	10.4 Environmentally Sensitive Streams .....	54
	10.5 Procedures .....	55
<b>Section Eleven</b>	<b>Parking</b>	
	11.1 Guidelines .....	57
	11.2 Parking Lots .....	57
	11.3 Handicapped Accessibility .....	57
	11.4 Parking Dimensions .....	58
	11.5 Landscaping and Visual Screen Plantings .....	58
	11.6 Motorcycle Parking .....	59
<b>Section Twelve</b>	Publications Referenced .....	60
<b>Acknowledgements</b>	Acknowledgements .....	61
<b>Section Thirteen</b>	Appendix .....	62
	Product Specification Sheets	

**Hyperlinks to Clemson University Plans and Departments Referenced in Site Design Guidelines:**

- [Bikeway Design Guidelines](#)
- [Campus Tree Protection Policy](#)
- [Clemson University Master Plan 2002](#)
- [Clemson University Master Plan 2002: Design Principles, Design Guidelines, Planning Standards](#)
- [Riparian Corridor Master Plan](#)
- [Sign Design Guidelines](#)
- [Sustainability Action Plan](#)
- [Sustainable Green Building Policy](#)
  
- [Clemson University Facilities website](#)
- [Clemson University Planning and Design website](#)

**1.0 INTRODUCTION**

The [Clemson University Master Plan 2002](#) provides a framework for decision making that expresses a point of view regarding all aspects of the campus. The Plan identifies sites for new construction, enhanced landscape development, potential expansion of existing buildings and describes the continued use or reuse of existing facilities to achieve a functional and attractive physical environment and an appropriate sense of place.

The Site Design Guidelines serve as a guide for all site and landscaping improvements on the Clemson campus and are to be used in the following ways:

- The guidelines support the Campus Master Plan and describe the procedures and standards for the design of new facilities or the upgrading of existing components of the University campus. They provide general direction for the design of campus improvements so that the concepts outlined in the Master Plan can be implemented with a certain degree of standardization and so that a unified campus visual character can be maintained.
- The philosophy behind these guidelines is to provide design parameters in which creativity can flourish while maintaining overall campus planning objectives that reflect both broad philosophic principles and specific standards. They are not intended to be so constraining as to inhibit creativity.
- These guidelines reinforce the University's commitment to working towards a sustainable future by incorporating efficient land use, landscape design, transportation systems and green building techniques. The integration of sustainable planning, design and engineering practices into these guidelines is intended to balance the need for campus growth with the stewardship of the Clemson campus. By facilitating sustainable development, the University enriches its resources, meets the needs of the community and enhances its image, experience and culture.
- They provide the basis for evaluation by the University Planning and Design Office and University Facilities for proposed changes to the physical environment. As such, these guidelines will be instructive to architects, engineers, landscape architects, building committees and others involved in planning for change on the campus.
- As with any dynamic process, the nature of growth and change on the University campus and the application of these guidelines towards that process will modify over time. The University Planning and Design Office in cooperation with University Facilities will monitor these changes and modify these guidelines in response to the evolving campus.
- These guidelines are general in nature and are subject to broad interpretations by the users of this manual. Users of these guidelines shall assume legal responsibility and liability for all work performed for the University. Where federal, state or local codes or regulations differ from these guidelines then such codes or regulations shall supersede the guidelines. Users of this manual are advised to be familiar with the entire manual before initiating the planning or design of a project.

## Site Design Guidelines

### 2.0 INTRODUCTION

The University pedestrian system is a series of nodes of outdoor pedestrian activity and pathways which link the various facilities and open spaces into a cohesive fabric for the campus community. This section provides guidelines to aid in the creation of a coherent, convenient and safe pedestrian campus.

### 2.1 PEDESTRIAN NODES

Nodes are areas of focused pedestrian activity located at the junction of paths where surrounding uses or inherent amenities create gathering places.

Nodes addressed in this section are paved areas classified as quadrangles, plazas and courtyards.

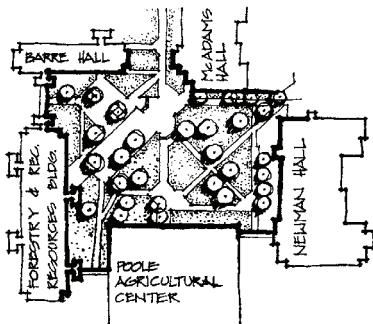

Quadrangle Agricultural Complex

#### A. Quadrangles

- Quadrangles are large open spaces, individual in nature and surrounded by buildings.
- Traversed by walks and paving, these spaces connect buildings and link quadrangles with paths that lead to other areas of the campus.
- Their features, such as paving, plantings and furnishings, reflect the character of the surrounding buildings and the pedestrian activities they support.
- Examples include the Agricultural Complex Quad, Harcombe Commons Quad, the Fraternity Quad and Bryan Mall.

#### B. Plazas

- Plazas are paved areas designed to accommodate a concentration of people who gather at intersections along the campus path system.
- Plazas may be found at building entrances or they may be specially designed to offer particular amenities.
- The small sitting area located just north of Rhodes Engineering is an example of a plaza at the intersection of two walks where people gather in passing.
- The plaza north of the Cooper Library provides a sitting area next to the reflection pond and is designed especially for people to assemble to take advantage of this amenity.

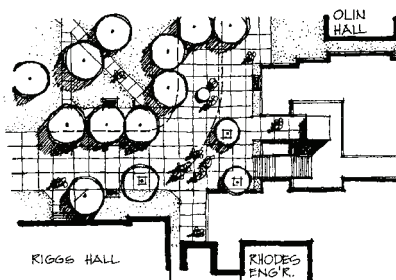

Rhodes Engineering Plaza

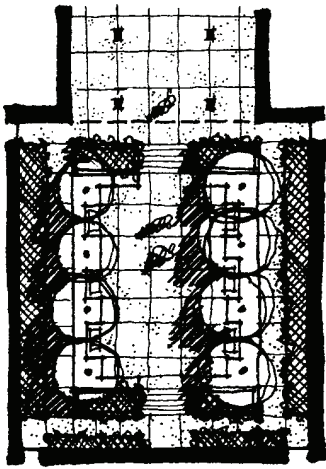

Lee Hall Courtyard

## 2.2 GUIDELINES

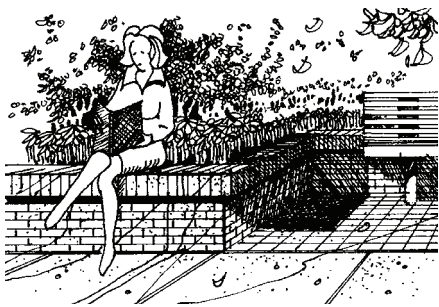

Seat Wall

### C. Courtyards

- Courtyards are small exterior spaces enclosed on three or four sides by building walls.
- They usually provide seating and plantings designed to be viewed from indoors or from above.
- These spaces are generally created to allow light into buildings and are often entered via adjacent buildings.
- The courtyard at Lee Hall provides an excellent example of this kind of node on campus.

### A. Size and Scale

- In designing a node, the size shall be based on existing and anticipated usage of the area with consideration given to the nature of the surrounding architecture.
- Factors to consider include: circulation requirements such as pedestrian and bicycle traffic volumes, access for emergency vehicles, fire trucks and service vehicles and functional requirements such as space for gathering, sitting, performing the display of art, etc.
- The design and placement of paving, furnishings and plantings shall be scaled to fit the character of the node. Narrow walks, small sitting areas and detailed plantings are appropriate for courtyards, while these may not be suitable for larger plazas expected to accommodate many more people.

### B. Seating and Furnishings

- Choice of site furnishings, such as benches, trash receptacles and signage shall be incorporated in all nodes based upon activities the node supports.
- Adequate seating for resting, waiting, meeting, sunning and many other activities is essential to the success of a pedestrian campus and shall be provided at all pedestrian nodes.
- The use of seat walls to increase sitting opportunities is encouraged if the wall also has other functional uses, like retention or container for plantings.
- Standards for Site Furnishings are located in Section 6: Site Furnishings.

## Site Design Guidelines



Pedestrian Orientation  
Signs and Landmarks

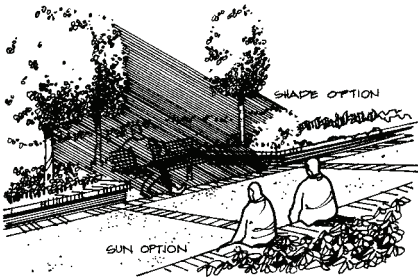

Micro-Climate

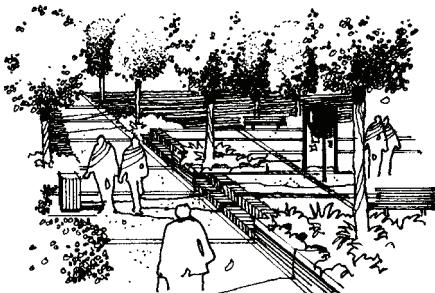

Transition from Path to Plaza

### C. Pedestrian Orientation

- An environment that provides clear direction and orientation to pedestrians is important to the perception of the campus as a cohesive whole.
- Designs for nodes and pathways shall include consistent and adequate signage to provide clear direction to pedestrians.
- Landmarks help new students and visitors gain a quick understanding of where they are and how to get where they are going.

### D. Micro-Climate

- Pedestrian nodes that incorporate seating areas shall be designed with consideration given to micro-climate conditions that affect the comfort of users.
- Large deciduous trees should be planted so that they provide shade for seating areas in summer and sun to those same areas in winter. Where existing or proposed seating effects sun penetration, orient nodes for southern exposure.
- Winter suntraps can be created by proper solar orientation and planting, but to be successful, cold winter winds and drafts must be minimized.
- Design quadrangles and plazas and place buildings and plantings in directions that will minimize these winter winds and capture the benefit of summer breezes.
- Planting trees next to seating areas is useful and important in creating a sense of enclosure and protection.
- Locate seating areas so that users will have a choice of sun or shade.
- Microclimate and vegetation are further addressed in Section 5: Vegetation Systems.

### E. Transition from Path to Major Plaza

- For a major plaza to be successful it must be on a path carrying many people and be attractive to those who use it.
- A major plaza shall be connected with the pathway it serves in an inviting way, and the physical and visual transition from path to plaza shall be gradual and harmonious.



- To provide a strong visual connection and enhance security, view lines between the path and the plaza shall be kept open and the grade change between the two shall be minimized.
- Shrubs and planters should not screen the plaza from adjacent walks nor should there be more than 5 to 7 steps from path to plaza.

F. Material

- The materials used in the construction of nodes shall be compatible with the surroundings. Generally, nodes shall repeat the materials used in adjacent walks and buildings.
- Small nodes such as sitting areas near walks, intersections and courtyards shall be paved with standard campus paving brick laid on sand cement with borders laid in mortar. Further information is located in Section 9: Paving.
- Larger areas, like quadrangles and nodes, also shall be paved with standard campus paving brick laid on sand cement with borders laid in mortar (if budget permits). Otherwise, such areas shall be paved in concrete with brick edges, dividers and designed with other details to be visually consistently with the rest of campus.
- Retaining walls, seat walls and other vertical surfaces shall be either brick or concrete and in relation to surrounding architectural treatments.

G. Planting Nodes

- Planting nodes establish identity and facilitate use and enjoyment by pedestrians.
- Plantings define edges, create enclosure, control micro-climates, direct viewing to specific areas and screen undesirable views.
- Plants for campus nodes shall consider the functional and aesthetic roles that vegetation play in node design.
- Guidelines for the use of plantings on campus are located in Section 5: Vegetation Systems and the Campus Tree List is located in the Appendix.

H. Lighting Nodes

- Proper lighting of nodes is essential to nighttime use and to pedestrian safety.
- Guidelines for lighting in pedestrian areas on campus are located in Chapter 7: Site Lighting.

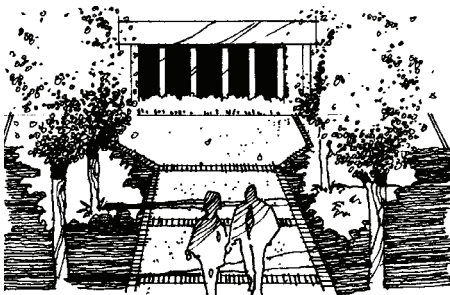

Planting Node

**2.3 PEDESTRIAN PATHS**

Pedestrian paths are the routes traveled by pedestrians that link nodes of activity. For the purpose of these guidelines, the only paths that this section addresses are paved walkways.

**A. Location**

- Walks should be routed in order to form logical connections between nodes of pedestrian activity and are vital to pedestrians’ perception of a cohesive campus.
- Walk layouts shall be analyzed to determine the most efficient and practical routing of path with the goal of minimizing expressive features such as ramps, stairs and retaining walls.
- Walk design shall accommodate existing and proposed buildings, site features, utilities, trees and desired routes of pedestrians, as well as provide access for emergency vehicles.
- The location of walks shall be determined by existing conditions and projections for future needs based on continuing studies by the University Planning and Design Office.
- The location and construction details of planned improvements shall be in compliance with the [Americans With Disabilities Act and Section 504](#) and the [Rehabilitation Act of 1973](#).

**B. Width**

- The minimum width of campus walks shall be:
  - General walkways: 6’
  - Primary building access walkways: 8’
  - Building services access walkways and East Campus Duplex Housing entrances: 4’

- The vast majority of campus walks will be wider than 6’ in order to accommodate pedestrian loads during class change.
- Attention shall be given to allow additional walk widths at the entrance to buildings, at vehicular drop-off areas and at other places where pedestrians congregate.

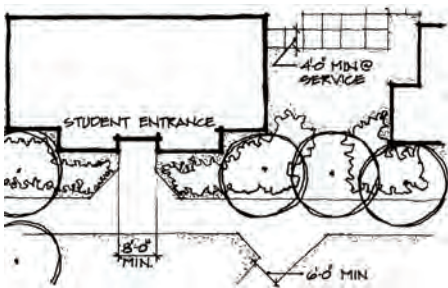

Minimum Widths of Walks

## Site Design Guidelines

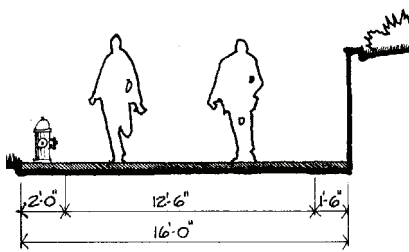

Proper Width of Walk

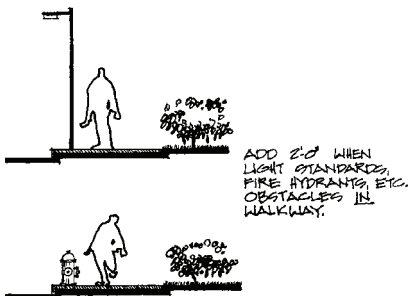
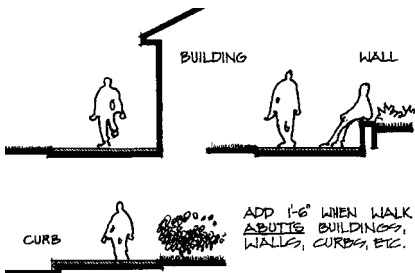

Additional Width of Walk

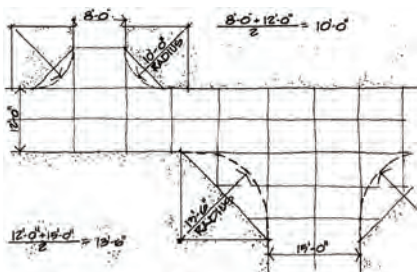

Walk Intersections

- The proper width of a walk shall be determined using the following formula based on pedestrian volumes during the peak period of sidewalk use.

$$(P/I \text{ divided by } 10) + X = \text{Width of Walk}$$

P = number of pedestrians anticipated to use the walk during the peak period.

I = duration of the peak period in minutes.

10 = constant factor representing the number of pedestrians per foot of width per minute during the peak period.<sup>1</sup>

X = additional width of walk due to obstructions or proximity to buildings or roadways.

- If one or more of the following conditions exist, then width shall be added to the walk, as follows:
  - 1'-6"- added to side of walk if the path abuts a building, retaining or planter wall or is adjacent to non-recessed benches, message boards, streets, curbs or edges where people are likely to stand.
  - 2' added to the path where there are traffic flow impediments such as parking meters, light standards, fire hydrants or other obstacles in the walkway.

Example: To determine the proper width of a walk that will accommodate 1500 pedestrians in 12 minutes, located with a retaining wall on one side and a fire hydrant in the walk on the other side, use the Width of Walk formula as follows:

$$(P/I \text{ divided by } 10) + X = \text{Width of Walk}$$

$$(1500/12 \text{ divided by } 10) + 1'6'' + 2' + \text{Width of Walk}$$

$$(12.5) + 1'6'' + 2' = \text{Width of Walk}$$

$$12'6'' + 1'6'' + 2' = 16'$$

The proper width is: 16'

## C. Walk Intersections

- The intersections of walks shall include paving that allows pedestrians to conveniently change from one walk to another without crossing lawns or planted areas.

<sup>1</sup> The standard for safety and convenience used in determining walk widths for this study was derived from methods and standards outlined in *Pedestrian Planning and Design*, John J. Fruin, Ph.D., Metropolitan Association of Urban Planners, Inc. 1971. For the Clemson campus, an average pedestrian standard of 10 PFM (pedestrians per foot width of walkway, per minute) was determined as the appropriate standard. (See Fruin, pages 71-88.)

Site Design Guidelines

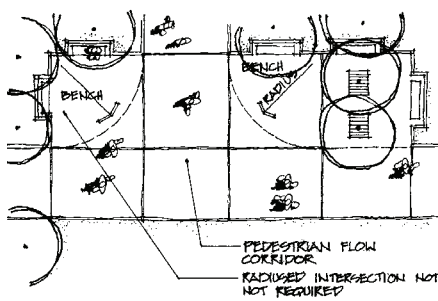

Seating Radii



Ramp Gradients

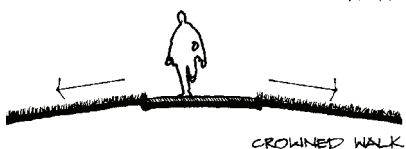
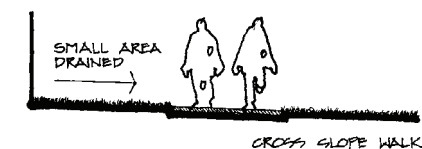

Walk Drainage

- At intersections that incorporate seating areas or other amenities, the area inscribed by the minimum radius shall be clear of furnishings or other obstacles.

D. Grading and Drainage of Walkways

- The layout of grading of campus walks shall strive to avoid steep walks, steps and ramps.
- The following gradients shall be considered in the design of campus walks:

Gradient	Use
0-2%	For ADA exterior accessible routes
0-3%	For generally accessible routes (the preferred walk gradient.)
3-5%	Acceptable gradient. Sustained grades of 3-5% along walks designated as handicapped routes should incorporate level areas, 5' minimum, approximately every 100 feet to allow points to stop and rest.
5-8%	Steep gradient. Walks within this range should be used with moderation. Walks within this range are considered ramps on handicapped routes and shall meet all requirements for handicapped accessibility. The maximum ramp gradient for handicapped accessibility is 8.33% (1:12).
8-14%	Extremely steep gradient. Walks within this range shall be used only for short distances of less than 20' and shall have textured surfaces to prevent users from slipping. To avoid 8-14% walk slopes, use steps where possible.
14%	Gradients steeper than 14% shall be traversed with a combination of steps and walks having acceptable gradients. Walks steeper than 14% shall be avoided wherever possible

- The grading of walks and areas adjacent to walks shall strive to direct storm water away from walks. Crowned walks are preferred to cross-sloped walks in areas of level ground. Cross-sloped walks shall only be used where a small area requires drainage.

E. Structural Design Considerations

- Structural deterioration of walks is most often caused by one of the following conditions:
  - Improper construction and/or materials
  - Moisture beneath walks and poor drainage conditions
  - Overloading by heavy vehicles
  - Upheaval by tree roots
  - Freezing and/or thawing conditions
- Every effort shall be made in the design of walks to address the common problems listed above. Before designing new walks or improvements to existing walks, knowledge of existing and future pedestrian and vehicular traffic requirements, soils conditions, and the presence of tree roots, the location of utilities and other factors affecting walk design shall be considered.

F. Expansion of Existing Walks

- Existing walks that are too narrow for anticipated or actual pedestrian traffic volumes shall be widened to accommodate traffic demands, where conditions permit. Widening shall be accomplished by adding brick paving to the edge of existing walks. The addition width of the brick to any side of an existing walk shall not exceed 1/3 of the width of the existing walk.
- Where brick is added to existing walks, proper compaction shall be used so that differential settling between the existing walk and new brick does not occur.
- The demolition and repaving of existing walks shall be required when conditions of grade, subsoil, drainage or other factors do not allow expansion by adding brick, or where the amount of widening required to handle pedestrian traffic causes the brick addition to exceed 1/3 of the existing walk.

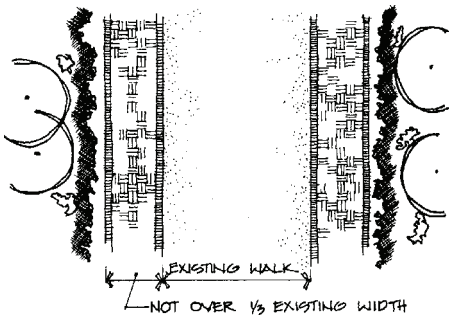

Expansion of Existing Walk

2.4 ROAD INTERSECTIONS

Pedestrian walkways cross different types of roads that serve the campus. Road type descriptions are located in Section 3: Vehicular Systems.

- Design of pedestrian crossings of roadways shall consider vehicular signals, routing of bicycles, signage, accessibility for the handicapped, visibility and crossing designations on pavement. Site furnishings, such as bollards, can provide further definition.

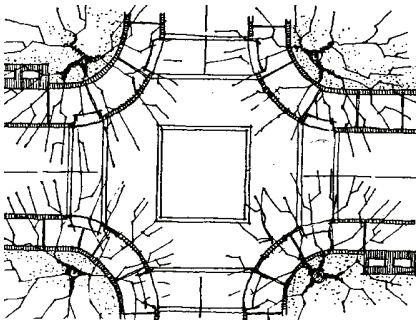

Crossings of Arterial and Secondary Roads at Road Intersections

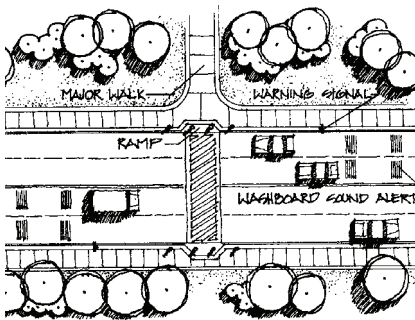

Crossings of Arterial and Secondary Roads Not at Road Intersections

- General Guidelines for Pedestrian Crossing and Roadways
  - Provide “barrier-free” access.
  - Walks should be aligned with crossings. If necessary, realign existing walks to crossings.
  - Utilize curb ramps where curbs exist.
  - At all pedestrian crossings, provide signs to alert motorists and bicyclists of the crossing.
  - Maintain unobstructed visibility between pedestrians and motorists for a distance appropriate with the speeds of the vehicles.
  
- Crossings of Arterial and Secondary Roads at Road Intersections
  - Paint white lines across the road to designate crosswalks. Crosswalks should extend all the way across the road and be as wide as the path they serve. They should be marked by painted 8” side transverse lines on each edge.
  - Where the intersection has vehicle traffic control signals, then two transverse lines are sufficient. Where there is no vehicle signalization, paint 8” or 12” wide perpendicular lines 30”-36” apart between the transverse lines.
  - Deviations from guidelines stated above may be warranted to improve safety on a case by case basis.
  
- Crossing of Arterial and Secondary Roads Not at Road Intersections
  - Apply the eight (8) guidelines as listed in the previous two bullet points.
  - Incorporate type B-1 bollards 18” from the edge of the roadway and 6’ apart to designate the crossing.
  
- Crossings of Tertiary Roads
  - Use walk paving material, either brick or brick edges and dividers in a concrete field, across the roadway to delineate the crossing between, pedestrians, bicyclists and motorists.
  - Incorporate type B-1 bollards 12” from the edge of the roadway and 6’ apart to designate the crossing.
  - Utilize trees and low shrubs or groundcover on both sides of crossing to delineate crossing.

Site Design Guidelines

2.5 STEPS

Detailed design elements found in pedestrian nodes and paths form the basis for a unified design treatment of campus pedestrian systems.

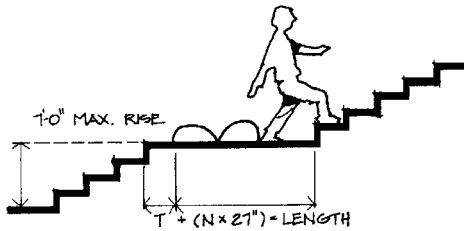

Length of Landing and Rise Between Landings

$$\text{Length of Landing} = T + (N \times 27'')$$

T = Step tread depth

N = Number of paces (Usually a minimum of 3 and where possible, an odd number)

27'' = Average stride of pedestrians

A. Steps

- Steps shall be at least as wide as the width of walks they serve.
- Landings shall be at least as wide as incoming steps.
- The desirable length of a landing is based on the average stride of pedestrians and shall be calculated as follows:

- The maximum rise between landings shall be 7' vertical. Where ramps are incorporated with steps, consider the coordination of step landings and ramp landings.

- The preferred design for steps in the outdoor environment incorporates a lower riser in relation to the tread when compared to indoor steps. This is due to the longer stride that people take when walking outdoors. Exterior steps should incorporate a relationship between the riser and tread in which twice the height of the riser plus the depth of the tread falls somewhere between 26'' and 29''. A 5 1/2'' riser with a 17'' tread is recommended where steps ascend planted banks. This relationship provides a 3:1 embankment that is desirable for maintenance. All steps in a series should have a uniform tread width and riser height.

- The radius of curvature at the leading edge of the tread shall be no greater than 1/2''. Risers shall be sloped or the underside of the nosing shall have an angle not less than 60 degrees from the horizontal. The undersides of nosing shall not be abrupt. Nosing shall project no more than 3/4'' from the face of the riser.

- All exterior stairs shall have handrails on both sides that comply with the paragraph on handrails below. Adherences to all of these sections provide a cohesive treatment throughout the University campus. Further specifications are located in Section 6: Site Furnishings and in the Appendix.

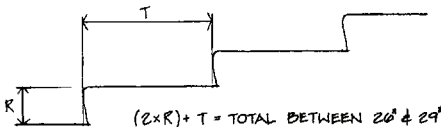
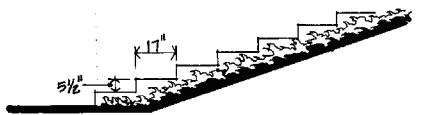

Riser/Tread Relationship

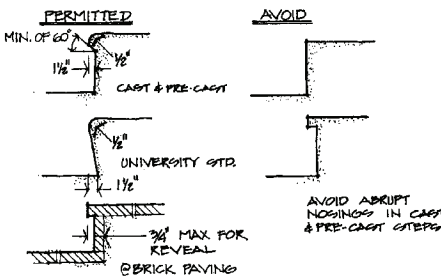

Step Nosing

**2.6 OUTDOOR RAMPS**

Guidelines for ramps shall be in compliance with the [Americans With Disabilities Act and Section 504](#) and the [Rehabilitation Act of 1973](#).

- Exterior steps shall have a lowest average level of light of 0.6 foot-candles. Light fixtures shall cast light down towards the riser so that treads will not be in shadow. Further specifications are located in Section 7: Site Lighting and Appendix.
- The materials for exterior steps shall match the materials of adjacent pedestrian paving.

- Any part of a pedestrian walk with a slope greater than 1:20 (gradient of 5%) shall be considered a ramp.
- There are two (2) major classifications of exterior ramps on campus: curb ramps and walkway ramps.

**A. Curb Ramps**

- The placement of curb ramps shall depend on the location of drainage structures, fire hydrants, parking places, walkways and other site features. Curb ramps shall be located in such a way as to prevent their obstruction by parked vehicles.
- Slopes of curb ramps shall comply with the slopes given in the following walk ramp section.
- The minimum width of a curb ramp shall be 48"; exclusive of flared sides.
- Curb ramps at marked pedestrian crossings shall be wholly contained within the markings, excluding any flared sides.
- If a curb ramp is located where pedestrians must walk across the ramp, then it shall have flared sides; the maximum slope of the flare shall be 1:10.
- The surface of curb ramps shall be truncated domes.
- Curb ramps with returned curbs may be used where pedestrians would not normally walk across the ramp.
- Built-up curb ramps shall be located so as not to project into vehicular and bicycle traffic lanes.

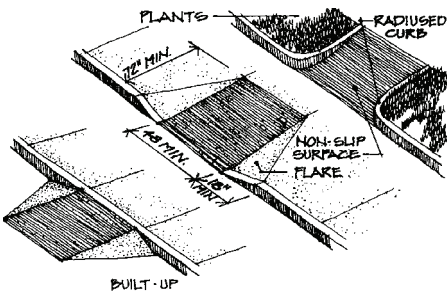

Curb Ramp Types



Site Design Guidelines

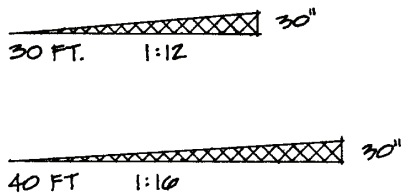

Walk Ramp Maximum Slope and Rise

B. Walk Ramps

- Any raised islands in crossings shall be cut through level with the street or have curb ramps at both sides and a level area at least 48" long of the island that is intersected by the crossings.

- The maximum slope of a ramp in new construction shall be 1:12. The maximum riser for any ramp shall be 30".

<u>Slope</u>	<u>Max. Riser</u>	<u>Max. Run</u>
1:12	30"	30'
1:16	30"	40'

- Curb ramps and ramps are to be constructed in conjunction with existing facilities and shall have slopes and risers as shown below, if space limitations prohibit the use of a 1:12 or less slope.

<u>Slope</u>	<u>Max. Riser</u>	<u>Max. Run</u>
Steeper than 1:10 but no steeper than 1:8	3"	2'
Steeper than 1:12 but no steeper than 1:10	6"	5'

- The minimum clearance width of a curb ramp shall be 72".
- Ramps shall have level landings at the bottom and top of each run.
- Landings shall have the following features:
  - Landings shall at the minimum, be as wide as the widest ramp run leading to it.
  - Landing lengths shall be a minimum of 60" clear at the top and 72" at the bottom of the ramp.
  - If ramps change direction at landings, the minimum landing size shall be 72" by 60".
- If half a ramp run has a riser greater than 6" or a horizontal projection greater than 72", then it shall have handrails on both sides.
- Handrails are not required on curb ramps. Handrails shall comply with the guidelines in the following section on Handrails, in Section 6: Site Furnishings and in the Appendix.

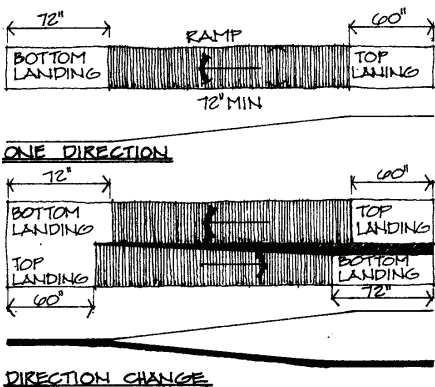

Walk Ramp Landings

Site Design Guidelines

2.7 HANDRAILS

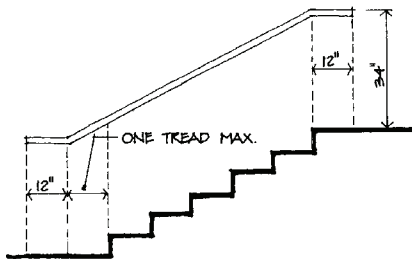

Wall Mounted Handrail at Steps

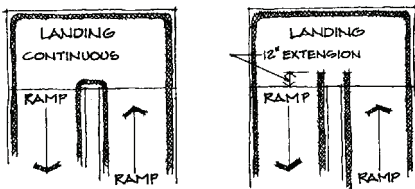

Handrails at Ramp Landings

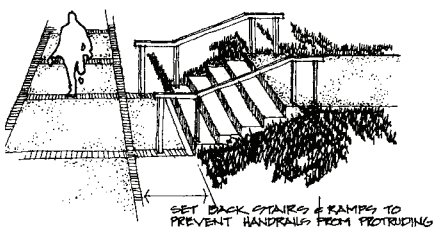

Avoid Handrail Protrusions

- Handrails must be placed on both sides of all steps and all ramps having a rise greater than 6" or a horizontal projection greater than 72".
- Handrails are placed to help people negotiate steps or ramps and differ in function from guardrails where the primary purpose is to protect people from abrupt drops. See Section 6: Site Furnishings and the Appendix for additional guidelines and specifications for handrails.
- Handrails at Steps:
  - Handrails must be continuous along both sides of stairs. Inside handrails on switchback stairs should be continuous.
  - If handrails are not continuous, they shall extend at least 12" beyond the top riser and be at least 12" plus the width of one tread beyond the bottom riser.
  - At the top, the extension shall be parallel with the ground surface. At the bottom, the handrail shall continue to slope for a distance of the width of one tread from the bottom riser; the remainder of the extension shall be horizontal.
- Handrails at Ramps:
  - Handrails must be provided along both sides of ramp segments. The inside handrail on switchback ramps shall always be continuous.
  - If handrails are not continuous, they must extend at least 12" beyond the top and bottom of the ramp segment and shall be parallel with the ground surface.
- Handrail protrusions:
  - Handrails shall not protrude into walks or passageways more than 4".
  - Stairs and ramps shall be set back sufficiently from walks and passageways to prevent handrails from becoming obstacles to passing pedestrians.

**2.8 GUARDRAILS**

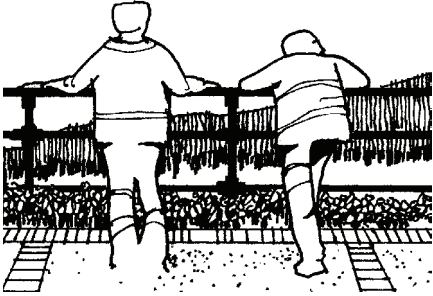

Guardrails

- Pedestrian Guardrails:
  - Pedestrian guardrails shall be used where a significant drop next to a walk, plaza, or other pedestrian area constitutes a safety hazard.
  - See Section 6: Site Furnishings and the Appendix for additional guidelines and specifications.

**3.0 INTRODUCTION**

The University’s vehicular system shall accommodate traffic needs and ensure pedestrian and bicyclist safety and maintain the aesthetic qualities of the campus. The [Clemson University Campus Master Plan 2002](#) designates a hierarchy of roads, based on their scale, speed and character appropriate to their function, and are classified as Arterial, Secondary, and Tertiary Roads.

**3.1 GUIDELINES**

The design guidelines in this section describe the University vehicular system and its interrelationship with pedestrians and bicyclists, and provide recommendations for planting, building setbacks, utility easements, visibility triangles and parking. Further guidelines are located in Section 7: Site Lighting, Section 8: Signage and Section 11: Parking.

**3.2 ROAD HIERARCHY AND CHARACTER**

- A. Arterial Roads:
  - Arterial roads are moderate speed routes looping around the periphery of the academic and housing areas of the University. As primary entrance ways into the campus, they provide the initial impression to visitors and portions shall be landscaped to emphasize a “gateway” experience.
  - Arterial roads include:
    - *US Highway 76*: As the entrance to the University from the north and south, US Highway 76 provides an introduction to the Clemson campus.
    - *SC Highway 93*: As a gateway leading to Tillman Hall, SC Highway 93 highlights the dedicated open space associated with President’s Park and Bowman Field and serves to delineate the campus from the town.
    - *Perimeter Road*: As the functional and aesthetic connection between US Highway 76 and SC Highway 93, Perimeter Road forms the loop on the southern edge of campus.
- B. Secondary Roads
  - Secondary roads connect arterial roads, tertiary roads and parking areas and provide access to and from the campus core.
  - Secondary roads include:
    - *Cherry Road*      · *Williamson Road*      · *Centennial Blvd*
    - *Newman Road*      · *S. Palmetto Blvd*

C. Tertiary Roads

- Tertiary roads provide a low-speed connection between secondary roads and campus core buildings, parking and service areas. They incorporate parking for visitors and staff, and their roadways can be shared by vehicles and bicycles.

There are two types of Tertiary Roads:

- . Tertiary/Secondary: Connecting parking and service areas with tertiary roads and are generally vehicular in nature.
- . Tertiary/Cul-de-sac: Located in the core of the pedestrian campus, they utilize signage, plantings, furnishings and paving to create a pedestrian scale and provide pedestrian safety.

3.3 LANDSCAPING

US Highway 76

- Landscaping shall consist of an informal naturalistic arrangement of large native, deciduous and evergreen trees and masses of large shrubs.
- To create a sense of arrival, the plantings at the southern end of the campus shall be brought close to the road and open up just north of the entry point.
- Flowering trees, median plantings and open space corridors shall be used to supplement this effect.

US Highway 76 Landscaping

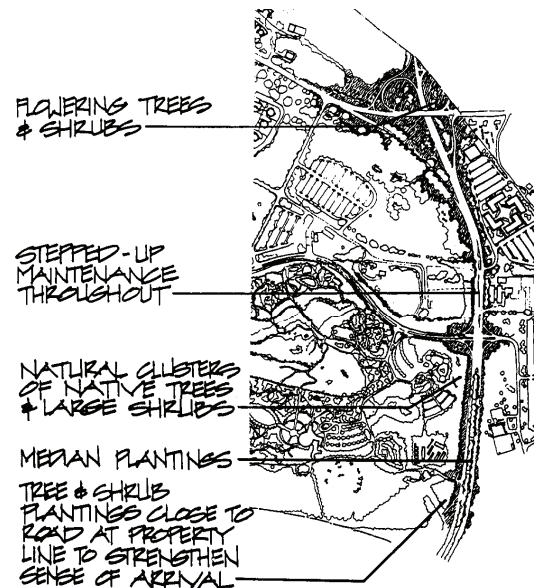

#### Perimeter Road and Newman Road

- Landscaping shall consist of an informal naturalistic arrangement of large native, deciduous and evergreen trees and under plantings of small flowering trees.
- To create an aesthetically pleasing experience, the median strips at the intersection with US Highway 76 should be planted with appropriate landscaping.
- For maintenance purposes, use low groundcover shrubs in lieu of grass.

#### Secondary Roads

- Landscaping shall consist of an informal groupings of deciduous and evergreen trees, and under planted with flowering trees that can be brought up to within 15' of the roadside edge.
- Planting on these roads can also double as a screen from parking areas but designed so as not to create any safety issues.
- A streetscape effect of uniformity and identity can be achieved by planting similar trees planted in sequence with a common distance "on center."

#### All Tertiary Roads

- Landscaping shall consist of informal groupings of deciduous and evergreen trees and under plantings of small flowering trees.
- At intersections with secondary roads, situate trees at an angle so that their limbs will ultimately overhang the roadway and form an enclosure.
- Where there is no sidewalk adjacent to the road, set back shrubs 5' from the edge of the road and set back trees a minimum of 10' from the edge of the road.
- Maintain a clear distance of 12' above the road to accommodate tree limbs.
- Planting location for trees and shrubs shall be coordinated with existing and future utility corridors and set-backs from roads adjusted accordingly.

#### Tertiary/ Cul-de-sac Specific

- Plant large deciduous trees at:
  - Islands formed by major pedestrian crossings.
  - Islands between parking spaces at a minimum of 1 tree for every 6 spaces.
  - Along walks associated with parking areas.

**3.4 BUILDING AND PARKING  
SETBACKS**

- Planting islands shall be enclosed with a minimum of a 6" curb and trees shall be located no closer than 4' from the back of island curbs.
- Where space permits, plant the center of cul-de-sacs with ground cover, shrubs and trees, taking care not to obscure motorists sight lines across the cul-de-sac.

US Highway 76:

- To emphasize the gateway experience, no buildings or parking areas shall be permitted to be constructed within the open space corridor.

SC Highway 93:

- To preserve the existing open space character no buildings or parking areas shall be permitted to be constructed in the dedicated green space associated with President's Park and Bowman Field.
- On the west end of campus, building setbacks shall be 150' from the edge of Highway 93, with the exception of Riggs Field, Sloan Tennis Center and Mell Hall.

Set backs shall be measured from the edge of the road or the face of the curb, whichever is closer to the centerline of the road.

Perimeter and Newman Roads

- Building setbacks: 100'
- Parking setbacks: 75'

Secondary Roads:

- Building setbacks: 75'
- Parking setbacks: 40'

Tertiary/Secondary Roads:

- Building setbacks: Shall be determined on an individual basis by the University Planning and Design Office.
- In every case, setbacks shall accommodate future pedestrian walks and utility requirements in the area.

Along Tertiary/Cul-de-sac Roads:

- Building setbacks: 25'
- Building setbacks shall be determined on an individual basis by the University Planning and Design Office. Consideration shall be taken to accommodate future pedestrian walks, utilities, connections with other roads, parking and siting of new buildings to form nodes of pedestrian activity.
- Parking lot road setbacks: 20'

### 3.5 UTILITY EASEMENTS

Easements shall be free of tree and shrubs for accommodation of future utility requirements for the area.

#### Perimeter and Newman Roads

- 20' from both sides of the pavement.

#### All Tertiary Roads

- 15' from both sides of the pavement or bike lane.

#### Tertiary/Cul-de-sac Roads:

- Setbacks shall accommodate future utility requirements for the area.

### 3.6 VISIBILITY TRIANGLES

All visibility triangles are measured from the edge of the road.

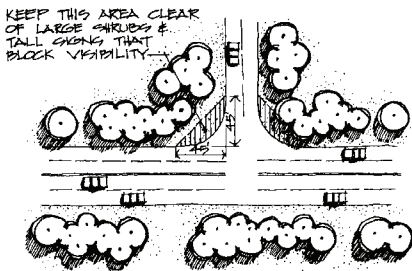

Visibility Triangle

#### Perimeter Road and Newman Road

- All intersections: 45' visibility triangle

#### Secondary Roads

- Intersections with arterial roads: 45' visibility triangle
- Intersections with tertiary roads and parking lots: 25' visibility triangle

#### All Tertiary Roads

- Intersections with secondary roads: 25' visibility triangle
- Intersections with arterial roads: 45' visibility triangle

### 3.7 PEDESTRIANS

#### US Highway 76

- Pedestrian crossings shall be permitted only at the signal controlled intersection with Perimeter Road.

#### SC Highway 93, Perimeter Road and Newman Road

- Pedestrian crossings shall be at traffic signals and well-delineated.

#### Secondary Roads

- Pedestrian crossings shall be provided at all tertiary road intersections and be well-delineated. To establish uniformity, similar type signage, planting and lighting details shall be used.
- Provide similar treatments to the entrances of parking areas to differentiate them from arterial roads.



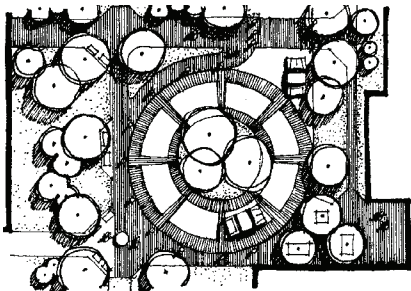

Tertiary Cul-de-sac

**3.8 BICYCLES**

Refer to Section 4: Bicycle Systems and the [Clemson University Bikeway Design Guidelines](#) for information and specifications regarding vehicular and bicycle systems relationship and integration.

**3.9 PARKING ACCESS AND ROAD WIDTHS**

Arterial Roads

- Road and parking access points shall be at least 500' apart.

Secondary Roads

- Road and parking access points shall be at least 150' apart.

Tertiary Roads

- Tertiary road widths shall be relatively narrow: 20' on roads with parallel parking and 24' on roads with 90 degree parking.
- Road widths shall be 20' where no parallel parking is present.

All Tertiary Roads

- Pedestrian crossings shall be well-delineated and shall utilize signage, plantings, furnishings, lighting and paving materials to make them clearly visible to motorists.
- Pedestrians shall have the right-of-way at pedestrian crossings.

Tertiary/Cul-de-sac Roads

- To identify cul-de-sacs as pedestrian zones where vehicles, bicycles and pedestrians must integrate in an area normally used by vehicles, design cul-de-sacs with pedestrian paving materials, bollards, furnishings, plantings, lighting and other devices.
- Establish pedestrian scale at intersections and maintain the scale throughout the road until it terminates in a cul-de-sac.
- Offset alignment of roads at 45 degrees at major pedestrian crossings, and require vehicular and bicycle traffic to stop before crossing.
- To designate the end of vehicular traffic and to provide security for pedestrians incorporate bollards where walks join cul-de-sacs.

- Tertiary road alignment shall be designed to accommodate vehicles with special requirements such as service vehicles or buses and shall incorporate turning radii and clearances in accordance with fire department regulations.

Tertiary/ Cul-de-sac Specific

- 90 degree parking:
  - Shall be on one side of the road (with the exception of Morrison Road).
  - Parking spaces shall be 9' x 20' (face of curb to aisle).
  - Roadway/parking aisles shall be 24' wide.

**3.10 TRANSIT STOPS**

The University's transit system is an integral part of the overall campus transportation plan and the design of transit stops shall follow these guidelines:

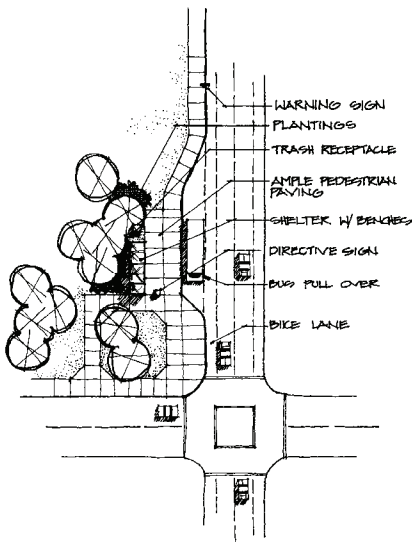

Transit Stop

- Transit stops shall be located at the intersections of major walks and secondary roads.
- The campus pedestrian system shall be designed in coordination with anticipated transit stops to maintain safety and utility.
- All transit stops shall provide:
  - Ample space for pedestrian gathering, seating, trash receptacles, lighting and shelter from inclement weather.
  - Directive signage indicating the location of the stop and its relationship with the transit system on campus.
  - Ample lighting for nighttime safety.
  - Landscaping with shrubs and trees to blend the transit stop with its surroundings and provide a controlled microclimate.
  - Safe routing for bicycles through the transit stop.
  - Specifications for site furnishings at transit stops are located in the Appendix.

**3.11 PROCEDURES**

- Improvements to the University's vehicular system shall include the proper planning and design of roads and parking surfaces as well as appropriate plantings, furnishings, signage, lighting and other features as recommended in these guidelines.
- The location and construction details of planned improvements to the campus vehicular system shall be reviewed by University Facilities in concert with the University Planning and Design Office for compliance with the [Americans With Disabilities Act and Section 504](#) and the [Rehabilitation Act of 1973](#).

Site Design Guidelines

3.12 ROAD GUIDELINES  
GRAPHICS

SC Highway 93

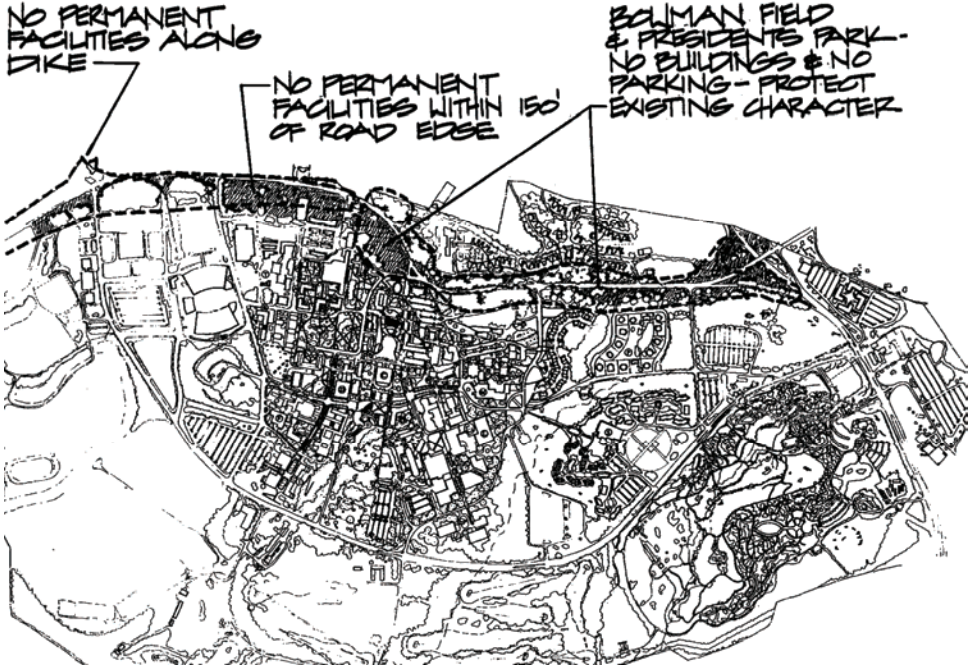

Perimeter & Newman Roads

- 20' UTILITY BASEMENT BOTH SIDES OF ROAD
- PARKING SETBACK 75'
- BUILDING SETBACK 100'
- ROAD & PARKING ACCESS POINTS 500' APART MIN.

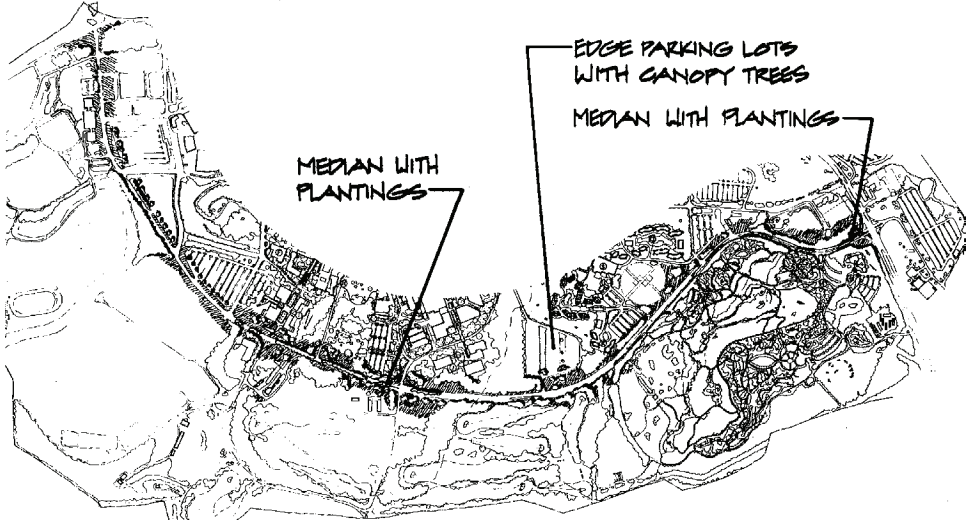

Site Design Guidelines

3.13 ROAD SETBACKS AND  
WIDTHS GRAPHICS

Secondary Road Setbacks

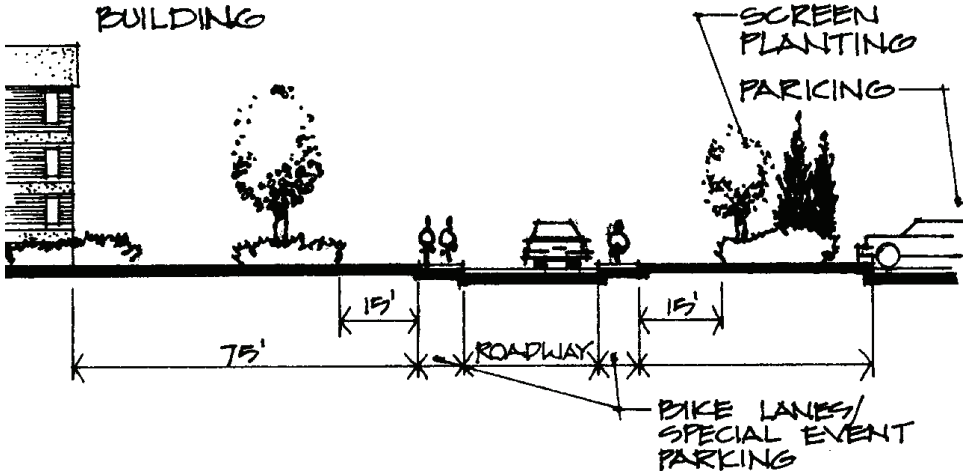

Tertiary Road Setbacks

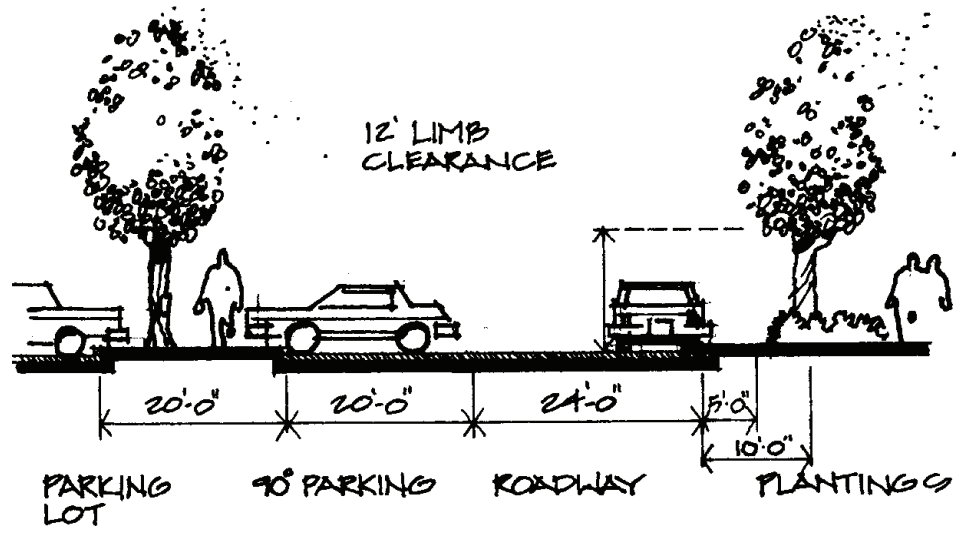

# CAMPUS ROAD HIERARCHY MAP

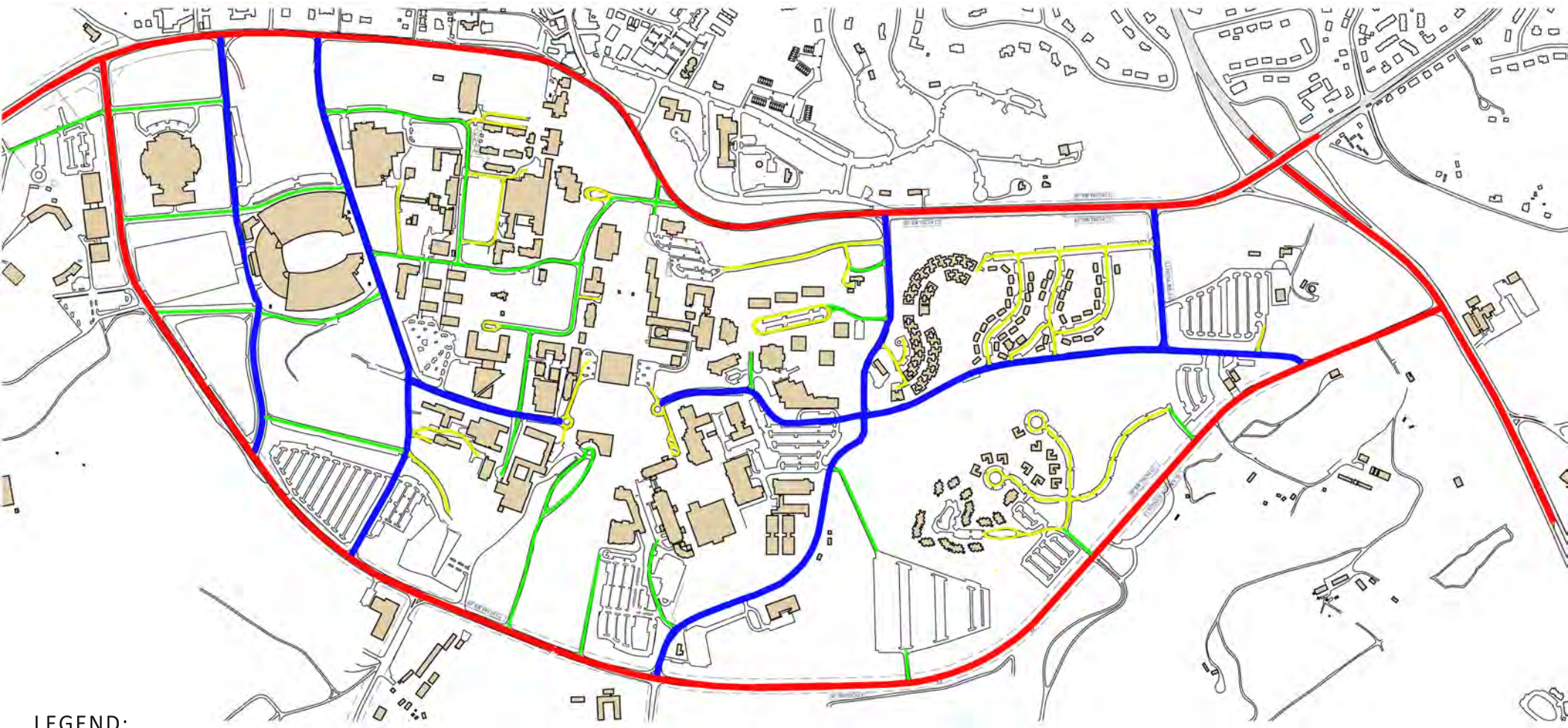

## LEGEND:

- ARTERIAL ROADS
- SECONDARY ROADS
- TERTIARY ROADS
- TERTIARY/CUL-DE-SAC ROADS

#### 4.0 INTRODUCTION

The [Clemson University Bikeway Design Guidelines](#) provide specific recommendations for implementing a bikeway system to promote safety and develop a robust network of commuting and recreational pathways that connect the entire extended campus. It shall be designed as a series of bikeway facilities on campus and within the Clemson Experimental Forest to serve students, staff, faculty, alumni, visitors and community members.

This section provides guidelines regarding:

- Shared roadways: roads designated by signage for shared use by motor vehicles and cyclists.
- Bike lanes: travel lanes that are portions of roadways designated for the exclusive use of cyclists with striping, signage and pavement markings.
- Shared use paths: bikeways, shared with pedestrians and prohibitive to vehicular traffic, which can be designed to provide recreational riding opportunities.
- Bike parking and storage.
- Bikeway signage.

Refer to the [Clemson University Bikeway Design Guidelines](#) for further information and specifications regarding bikeway facilities and for a detailed Campus Bikeways Map.

#### 4.1 SHARED ROADWAYS

Shared roadways are roads designated by signage for shared use by motor vehicles and cyclists. As a connection between bike lanes and shared use paths, they help to form a network of infrastructure for cyclists' use and provide a link with bike parking and storage areas at designated points on campus.

For safety reasons, the following should be considered when designating bicycle routes on roadways:

- Vehicular speed limits
- Street and gutter widths
- Proper drainage
- Drain inlets and sewer obstructions
- Adequate signage
- Pavement condition
- Lane widths
- Debris

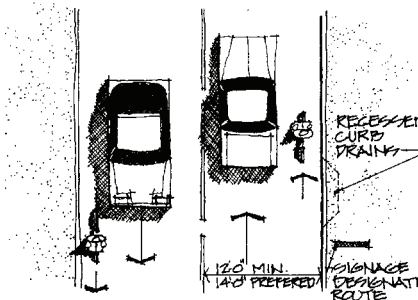

Shared Roadway

Refer to the [Clemson University Bikeway Design Guidelines](#) for further information and specifications regarding shared roadways and lane markings.

#### 4.2 BIKE LANES

Bike lanes are portions of roadways designated for the exclusive use of cyclists with striping, signage and pavement markings. Free of vehicular traffic, they are an important safety measure for cyclists and motorists and a designated place for cyclists to ride.

Recommended guidelines for bike lanes include:

- Preferred minimum width: 5' plus 1' gutter pan
- Allowable minimum width: 4' plus 1' gutter pan
- Widths may need to be adjusted if drain inlets and utility covers are present and effect or reduce useable width of lanes.

Refer to the [Clemson University Bikeway Design Guidelines](#) for further information and specifications regarding:

- Bike lanes and vehicular turning lanes
- Uphill bike lanes (also known as bicycle climbing lanes)
- Bike lanes through major intersections
- Bike boxes
- Traffic control facilities and loop detectors
- Bike lanes adjacent to parallel and diagonal parking

#### 4.3 SHARED USE PATHS

Shared use paths are bikeways, shared with pedestrians and prohibitive to vehicular traffic, which can be designed to provide recreational riding opportunities. They should be designed for shared use by bicycles and for shared use by pedestrians.

Recommended guidelines for shared use paths include:

- Minimum width: 10'
- Minimum clearance to obstructions: 3' lateral clearance  
8' vertical clearance
- Maximum design speed: 20 mph paved path  
15 mph unpaved path
- Consideration should be given to providing adequate lighting, proper drainage, useful signage, choice of pavement material and type of vegetation.
- More detailed guidelines are located in the [Clemson University Bikeway Design Guidelines](#).

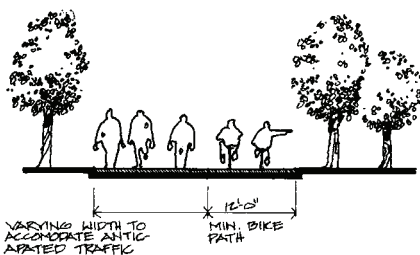

Shared Use Path

## Site Design Guidelines

### 4.4 BICYCLE PARKING AREAS

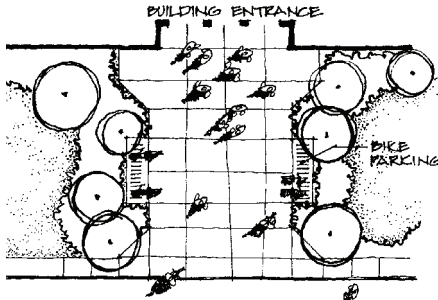

Bicycle Parking Outside Building

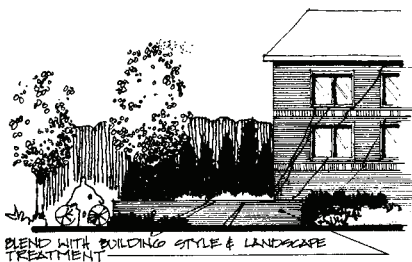

Bicycle Parking Area Blended with Surroundings



Bola Bike Rack

Bicycle parking is a support facility that provides short term bicycle storage at designated areas such as academic buildings, students centers, libraries and athletic facilities. Short term parking is recommended when storing a bicycle for a short period of time, quick activities or errands. Bicycle parking is a critical support component to bikeways. Bicycle parking areas differ from bicycle storage areas in that storage areas are used for long term parking and storage of bicycles.

#### A. Location

- Bike parking areas will vary according to the individual situation but shall be conveniently located within 50' of the destination they serve.
- Where possible, shelter should be provided over bike racks to protect bicycles from exposure to the elements.

#### B. Layout

- The following dimensions shall be used in the design of bicycle parking areas:
- Minimum bicycle space: 3' wide x 5' long
- Distance from curb: 24" - 30"
- Maneuvering space where: rack parallel and adjacent to a walk: 4'  
rack not adjacent to a walk: 6'
- Minimum distance from crosswalk/intersection: 5'
- Minimum distance from street furniture: 3'
- Minimum distance between bike racks: 4'
- Minimum space requirement: 1 space per 10 students

Bicycle parking areas shall be integrated:

- Aesthetically with adjacent pedestrian walks, plantings and lighting.
- With drainage and grading of surrounding areas.

#### C. Racks

- The bike rack recommended for campus is the Bola Bike Rack. Specifications for the Bola Rack are located in the Appendix.
- Should support bicycles frames at two (2) different points and be mounted into the ground.
- Shall allow for the standing and locking of all types of bicycles, minimizing both damage to the bikes and the possibility of theft.



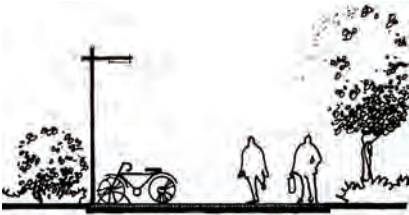

Security Lighting

#### 4.5 BICYCLE STORAGE AREAS

##### D. Security

- Bicycle parking areas shall provide security to the cyclists and their bicycles with ample use of lighting from Type C lighting fixtures located to provide a minimum of 1.0 footcandle of illumination. Refer to Section 7: Site Lighting for lighting specifications.
- Bike racks should be located in visible areas, close to buildings to encourage bicycling as a viable travel option and outside of landscape screening areas to minimize theft or vandalism.

Long term bicycle storage areas are designated areas at dormitories and buildings and other campus locations for the campus community.

##### A. Location

- Bike storage area locations will vary depending upon the configuration of the building and available space.
- In some instances, a central storage area may serve more than building.
- Generally, a bike storage area shall be convenient for the student and afford ready access to a bikeway.
- Where possible, shelter should be provided over bike racks to protect bicycles from exposure to the elements.
- Bike storage areas for cyclist commuters shall be conveniently located near bikeways/ commuting routes and within close proximity of campus buildings.

##### B. Layout

The layout of bicycle storage facilities shall:

- Provide easy access to bicycles.
- Minimize damage to bicycles due to overcrowding.
- Accommodate future expansion needs.
- Be integrated aesthetically with surrounding architectural elements.
- Where possible, include covered bicycle racks, bicycle storage rooms and lockers.
- Minimum space requirement:      The greater of 1 space per 10 students or 1 space per 10 employees or 1 space per 20,000 sq. ft. of adjacent buildings

#### 4.6 BICYCLE SIGNAGE

The Clemson bikeway signage shall be designed to communicate and inform cyclists about location of bicycle routes, destinations, parking, storage and mileage and be consistent with the character of other University signage.



Wayfinding Signs



Warning Signs



##### A. Wayfinding and Guidance Signs

- Wayfinding signs guide cyclists along a bike route and assist them in finding their way to specific destinations.
- Signs should be located after turns, when a route changes and at destination points.
- Connections between the campus and the Clemson Forest can be enhanced through informative signage.
- Pavement markings may be incorporated into the wayfinding system.
- Wayfinding sign examples include:
  - Bicycle route signs
  - Decision signs

##### B. Warning Signs

- Warning signs are highly-visible, cost-effective methods which advise motorists to share the road and to be aware of bicycle traffic.
- Signs should be consistently located on streets along bikeways, at vehicular intersections and near activity centers.
- By delineating shared roadways and bike lanes, warning signs help to ease interactions between pedestrian, bicycle and vehicular traffic and communicate expected behaviors among users.

#### 4.7 REFERENCES

The bikeway design guidelines recommendations in this document were developed by using national specifications and are in accordance with American Association of State Highway and Transportation Officials (AASHTO), the Manual on Uniform Traffic Control Design (MUTCD) and other state and national standard publications.

As innovations in bikeway facility design and standards are continually being developed, other resources should be consulted for more detailed information on recommended designs and treatments. For further reference, please refer to the most current publications of the following resources.

- [Clemson University Bikeway Design Guidelines](#)
- [Clemson University Sign Guidelines](#)
- [South Carolina Department of Transportation, Engineering Directive Memorandum 22](#)
- [1999 AASHTO Guide for the Development of Bicycle Facilities](#)
- [2009 Manual on Uniform Traffic Control Devices](#)
- [National Association of City Transportation Officials Cities for Cycling Urban Bikeway Design Guide](#)
- [FHWA Designing Sidewalks and Trails for Access Part II of II: Best Practices Design Guide](#)
- [2004 Characteristics of Emerging Road and Trail Users and Their Safety](#)
- APBP Bicycle Parking Guidelines, 2nd Edition (2010)
- [City of Greenville Bicycle Master Plan Design Guidelines](#)

5.0 INTRODUCTION

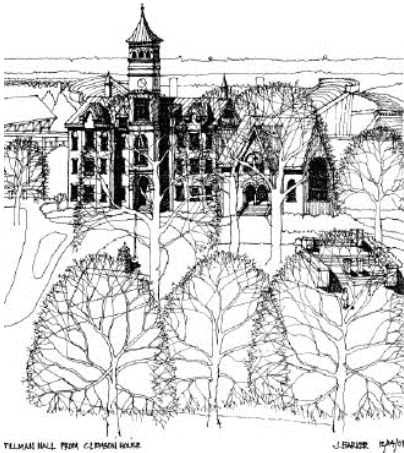

Plantings are one of the most significant elements of the Clemson University campus. In conjunction with buildings, properly designed and managed planting serves to establish a campus landscape character, creates an ecological sustainable landscape, helps reinforce open space and provides a comfortable, agreeable environment that is enjoyed by students, faculty, staff and alumni. Trees and plants play an important role in the University’s sense of place, identity, and permanence; and help maintain continuity on the campus, by tying old and new sections with varying architectural styles into a cohesive whole. Future additions to the campus should reinforce and enhance these principles in an environmentally sustainable, economical and low maintenance way.

5.1 LANDSCAPE CHARACTER

The campus landscape character shall be sympathetic with the natural aspects of the rural Piedmont setting of the University, have an orderliness that gives the campus a separate identity within its surroundings, and embrace environmental sustainability. The dedication of open space as required in the [Clemson University Master Plan 2002](#), will to a great extent, help create this character. This includes the retention and protection of parks, historical and environmentally sensitive areas along with the enhancement of open spaces such as the North-South spine that connects the campus core with facilities on Lake Hartwell.



The expansion of University facilities to accommodate new academic and support activities and planned changes in vehicular, pedestrian and bicycle systems, shall align the new system of dedicated open spaces with the University’s goal to be a model of environmental sustainability. Further, the incorporation of new plantings shall reinforce the natural setting of the campus while meeting architectural, engineering, climate control, sustainability, safety and aesthetic guidelines. More information regarding Clemson’s commitment to sustainability is located in the [Clemson University Sustainable Action Plan](#).

A. Guidelines for New Plantings

- Trees shall be predominately large, deciduous native varieties used in informal groupings rather than rows. An exception to this is allowed where trees are used to purposely form “arcades” in which the rhythm of the row is a vital component.
- A simplistic, unifying approach to planting design shall be used rather than “fussy” design, which co-mingles several species of plants in a small area.
- Size and texture of plantings shall relate to the scale they serve. In intimate areas such as courtyards, small gathering areas, and building entrances, the use of small plantings, fine textures and accent plants is appropriate.



## 5.2 GUIDELINES

- Foundation planting should not be “spotty” and individual shrubs along building walls should be removed. If massing of shrubs is not appropriate, grass or ground cover shall be brought up to building walls. To reduce maintenance, a moving strip shall be installed where the grass meets the wall.
- At Fort Hill, Tillman Hall and Hanover House, the historical character of the landscape shall be maintained with existing plant species and clipped forms.
- Planting plans shall be approved by the University Planning and Design Office upon completion of each phase of services prior to commencing the next phase.

### A. Architectural

Plants are selected for their qualities of form, color, texture and size to define an outdoor floor, ceiling or any combination of those elements. Used in combination, the selected plants give definition to outside spaces, just as floors, walls and ceilings define indoor spaces. The visual variety of plants and their seasonal changes make them a dynamic tool in architectural and space enhancement. A complete knowledge of the aesthetic and horticultural characteristics of plants, as well as analysis of the uses of spaces, is essential to good design.

### B. Engineering

Plants are selected for their qualities of root, bark, leaf and other physical characteristics to mitigate or solve environmental problems. These problems include erosion, sound and air pollution, traffic control, glare and reflection. A plant’s aesthetic function, in this use, is secondary to its physical properties. Plants have proven to be extremely effective in engineering capabilities, and in many cases prove to be cost effective.

### C. Climatological

Plants can be selected to achieve a more comfortable outside environment by influencing air movement, humidity and air temperature.

### D. Sustainability

Plants can be used for effective wind and water erosion control. The selective placement of plantings and light-absorbing qualities of leaves are effective in controlling temperature inside of buildings.

### E. Aesthetic Uses

Plant materials have functional as well as aesthetic characteristics. To use plants to their best advantage, a thorough knowledge of these characteristics, which include form, texture, color, fragrance and season interest, is required.

# Site Design Guidelines

### 5.3 USES

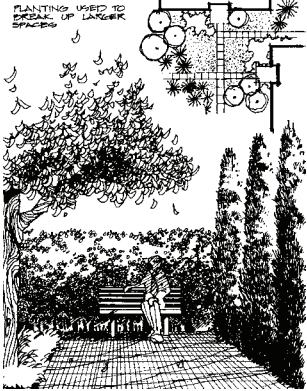

Architectural Uses of Plant Materials

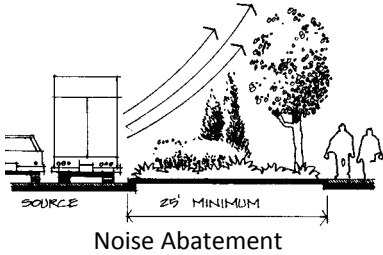

Noise Abatement

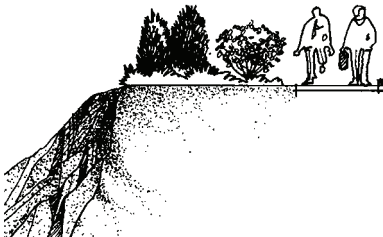

Traffic Control

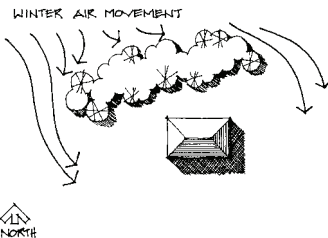
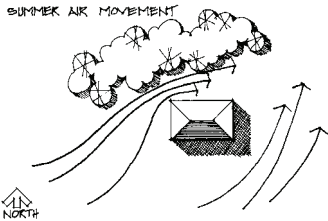

Air Movement Control

#### A. Architectural Use and Function

- Shrubs of various heights establish divisions of space and create enclosure.
- Plant materials can be used to break up larger spaces into smaller areas in relation to a particular building or group of buildings.
- Varying heights and types of plants used as screening add interest and function.
- Plants materials can direct views to landmarks that orient the viewer or to focal points that add to the enjoyment of the viewer.

#### B. Engineering Techniques:

- Plants used for noise abatement, are most effective if:
  - Trees and shrubs are used in combination, since shrubs are not high enough nor are trees branched low enough to the ground.
  - When used in borders, vegetation is planted lower toward the noise source and higher toward the hearer, thus directing unwanted noise upward away from the hearer.
  - In narrow planting beds a greater proportion of evergreens are used than would be planted in wider beds.
  - When screening highway noise, plant width should be from 25' to 35'.
- Several planting design techniques can be incorporated to reinforce safety and control traffic. Plants can be used to provide physical separation between pedestrian ways, bikeways and cars, and to divert pedestrian movement towards safer, more gentle slopes and away from steep, slippery slopes, retaining walls, drainage area, utilities, etc.

#### C. Climate Control:

- Shade trees and plants can directly and indirectly effect solar penetration and temperature.
  - Evergreens planted on the north side of buildings can provide a dead air space which helps prevent winter heat loss.
  - Deciduous trees on the south side of buildings or in seating areas can provide shade in the summer and allow warming solar rays to penetrate in the winter.
- Vegetation planted along shared use paths can create cool and comfortable environments for users.

## Site Design Guidelines



Rain and Humidity Control

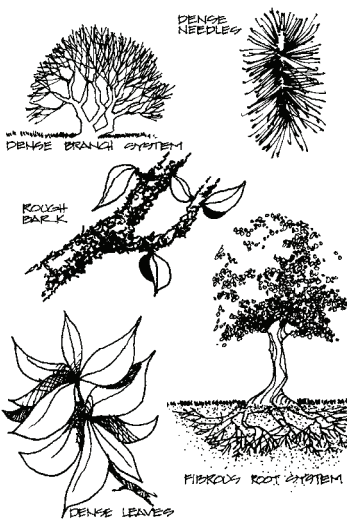

Wind Erosion Control

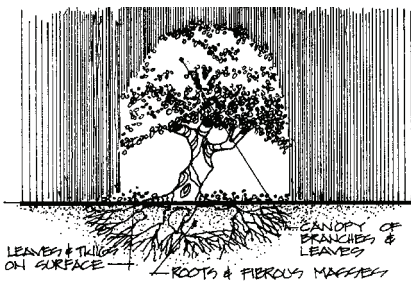

Water Erosion Control



Reduction of Glare and Reflection

- Plants can be used to control air movement, by blocking prevailing harsh winter winds or channeling cool summer breezes.
- Rain and humidity can be controlled with overhead canopies. Up to 40% of rainfall may be intercepted by the foliage of a dense evergreen overhead canopy, mitigating inclement weather on walkways. Humidity levels will increase with the density of the canopy, therefore canopies should have open space to allow air circulation to reduce humidity levels.

## D. Microclimate:

- Plants used as windbreaks for wind erosion control retard damaging wind in proportion to the height of the plants. The area protected by a plant wind break is twice the height of the windbreak upwind, and 18 times the height downward.
- Four (4) parts of plants which control wind erosion are:
  1. Dense leaves or needles which create an effective barrier to air movement.
  2. Multiple stems and dense bark that decrease wind velocity as it passes.
  3. Dense branching that controls and slows wind close to the ground.
  4. Fibrous surface roots that effectively hold surface soil in place.
- Plants can be used for water erosion control in at least three (3) ways:
  1. Leaves and branches form canopies interrupting rainfall and thus reducing splash erosion.
  2. Roots form fibrous masses within the soil and hold it in place.
  3. Leaves and other dead plant particles on the soil surface increase the organic material in the soil, aerating it and increasing its water absorption.
- The light-absorbing qualities of leaves reduce direct and reflected light away from cooling hard, reflective surfaces in direct proportion to the spacing and density of the plant material.

5.4 PROCEDURES

A. Preparation, Design and Approval of Planting Plans

Planting plans shall be prepared as an integral part of all plans for site improvements and/or building construction, be an integral part of the design and review process and consider long-range maintenance costs and sustainability.

- Planting plans must be designed to integrate existing features with consideration for the overall landscape context of the surrounding areas.
- Planting plans should be prepared by a licensed Landscape Architect.
- Planting plans shall follow, be presented and reviewed along with other plans for site and/or building improvements at each of phase of the design review process, i.e. schematic design, preliminary design, design development and contract documents. Cost estimates shall accompany each phase.
- Planting plans shall be approved by the University Planning and Design Office upon completion of each phase of services prior to commencing the next phase.

5.5 MAINTENANCE

A. Guidelines

- During selection consider horticultural requirements that will not create excessive maintenance costs.
- Shape lawn edges to conform to University lawn care equipment limitations to accommodate the turning of radii of the equipment and eliminate as much hand work as possible. Avoid lawns in small areas that require hand mowing and high maintenance materials in interior courts.
- Use shade tolerant groundcovers beneath dense tree foliage and in areas shaded by buildings where it is difficult to sustain grass.
- Select plant materials that accommodate design requirements in their natural form and do not need frequent clipping or pruning to satisfy the design concept. The natural form of plants is generally preferred over clipped forms. An exception is at Fort Hill, Tillman Hall and Hanover House where clipped forms are acceptable to retain the historical character of these areas.

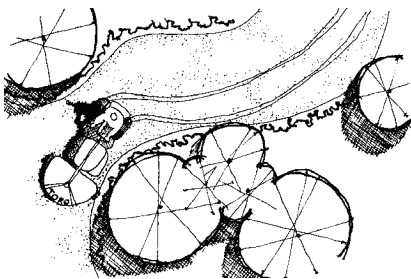

Lawn Edges To Accommodate Equipment

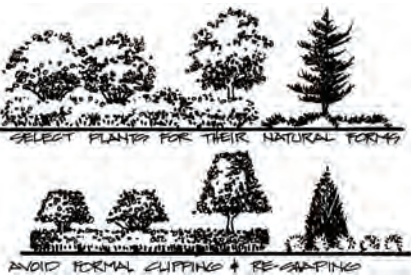

Natural Forms Preferred Over Clipped Forms



**5.6 PLANT LISTS**

- The University approved plant list is located in the Appendix.
- Deviations from the approved list shall be submitted through University Facilities to the University Planning and Design Office for approval.

# Site Design Guidelines

## 6.0 INTRODUCTION

The University’s standard furnishings for exterior spaces shall be aesthetically pleasing, visually unify the campus, integrate with the overall design of an area, be cost effective and easy to maintain. Site Furnishing specifications are located in the Appendix.

## 6.1 GUIDELINES

- The juxtaposition of benches, tables and chairs and other outdoor furniture will not only recognize the convenience and comfort of the user, but will also create opportunities for social interactions.
- Positioning of site furniture shall not hinder pedestrian or bicycle traffic flow and shall be situated to avoid damage by landscape maintenance equipment, such as lawn mowers. Placement of these furnishings may be in shrub or groundcover rather than grass to avoid damage by pedestrian traffic or lawn mowing equipment.
- Paving in and around benches and trash receptacles should be compatible with the design and material of the adjoining pedestrian paving and shall extend completely under the furnishing to avoid plant maintenance.
- Drinking fountains are not encouraged outdoors due to their inconsistent operation, but instead shall be located indoors.
- As the University strives to be on the forefront of technology by utilizing indoor interactive digital information centers, outdoor newspaper boxes and kiosks are generally not allowed, and shall be considered only in special circumstances.

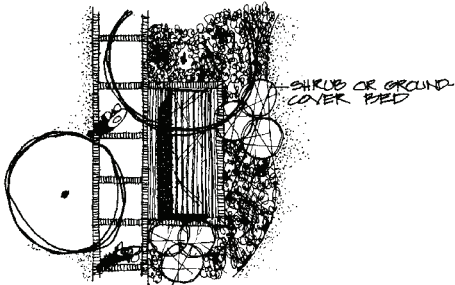

Shrubs As Groundcover

## 6.2 BENCHES

### A. Selection

There are five (5) standard campus benches:

Type	Description
B-1	8'-0" long with back
B-2	8'-0" long with without back
B-3	5'-0" long with back
B-4	5'-0" long with without back
B-5	Restoration Series for Historic District



B-1 Bench

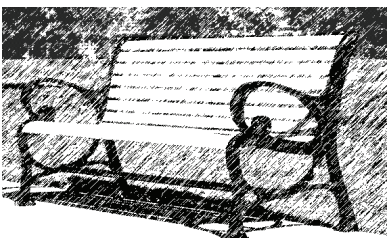

B-5 Bench

- The choice of bench depends upon pedestrian and bicycle circulation patterns, architectural surroundings, scale and aesthetic requirements of the bench location.
- The Restoration series benches shall be used in the Historic District and for donor recognition.

## Site Design Guidelines

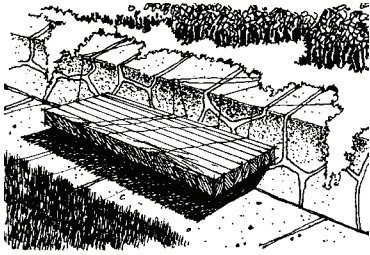

Non-Standard Bench

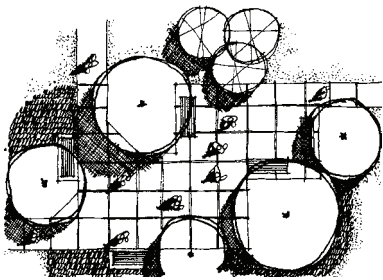

Bench Location

## 6.3 TRASH RECEPTACLES



R-1 Trash Receptacle

## 6.4 FENCES

- A non-standard bench may be appropriate where seating is incorporated into planter walls or integrated with specific architectural features. The bench design shall not create any special replacement or maintenance issues and will be more visually compatible in the environment than the standard bench.
- Walls intended as seat walls shall be at least 15" tall and no more than 24" tall, (17" is preferable). The depth of a seat wall shall be at least 15" when accessible from only one side and 30" minimum, (36" is preferable) when accessible from both sides.

## B. Location

- Place bench so that its face is 1'-6" from the edge of all walks.
- Situate to provide users with choice of sitting in the sun or in the shade.
- Place so seats are level avoiding a lengthwise slope greater than 4%. If the slope exceeds 4%, build up adjacent grade to create a level surface.

## A. Selection

There are three (3) standard campus trash receptacles differing in size and scale:

Type	Description
R-1	48" tall
R-2	30" tall
R-3	"Ironsides" for Historic District

- The choice of receptacle depends upon its location:
  - R-1 shall be used in most instances.
  - R-2 shall be used in small courtyards or other areas where a smaller scale is appropriate.
  - R-3 shall be used in the Historic District.

## B. Location

- Place trash receptacles so that their fronts are 12" back from walks.
- Trash receptacles shall be placed where pedestrian activity warrants their use, such as building entrances, waiting areas, plazas or other pedestrian nodes. Those receptacles located in seating areas should be an adequate distance from benches to minimize the effect of trash odors and insects on bench users.

- Fences have three (3) primary functions on campus. Fences are used as barriers to keep pedestrians from secured areas, to control vehicular movement or as visual screens to hide dumpsters, transformers, service areas, etc. from view.

## Site Design Guidelines

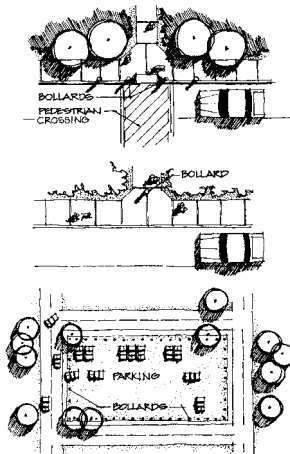

Screen and Barrier Fence

**6.5 BOLLARDS**

Bollard Locations

**6.6 MAILBOXES AND BOOK DROP CONTAINERS****6.7 PROCEDURES****A. Selection**

There are 4 standard campus bollards:

2 1/4" diameter

4" diameter

6" diameter

- Bollards are used on campus to control vehicular, bicycle and pedestrian traffic.
- Where they are used at pedestrian crossings, bollards are a visual signal to motorists warning them of the presence of pedestrians.
- Bollard specifications are located in the Appendix.
- Mailboxes and library book drop containers shall be conveniently clustered in close proximity to buildings.
- The standard campus free-standing mailbox outdoors shall be a regulation US Postal Service enclosure painted blue with red and white lettering and trim.
- Express mailboxes shall be labeled with express mail company logos and approved by the University Planning and Design Office.
- The standard library drop boxes are graphite in color and shall conform to University specifications.
- Proposed site furnishings shall be shown on all plans for new facilities and submitted to University Facilities and to the University Planning and Design Office for approval during the design review process.
- Standard site furnishings shall be used exclusively in plans and are available in the Appendix and from University Facilities.
- As standards are subject to change or as design may warrant, exceptions to site furnishing specification will be given consideration by the University Planning and Design Office in cooperation with University Facilities.

## Site Design Guidelines

## 7.0 INTRODUCTION

Lighting of walkways, bikeways, roadways and parking shall provide a safe and orderly traffic flow in and around campus and shall efficiently meet the energy conservation goals of the University.

## 7.1 GUIDELINES

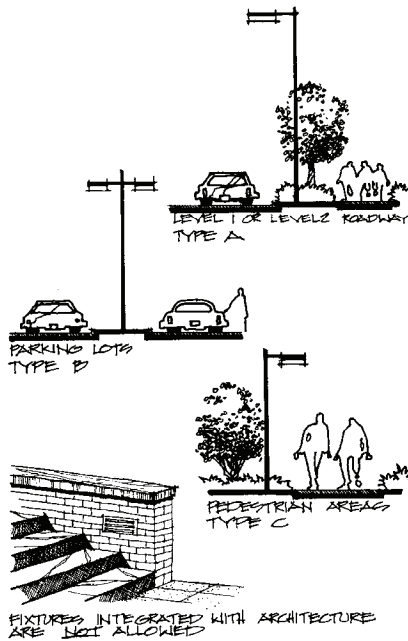

## 7.2 LIGHTING FIXTURES

## A. Selection and Location

Standard fixture types are selected according to their use.

Type A:	Roadway Shoebox
Location:	Arterial and Secondary roads Walks and bikeways adjacent to these roads
Type B:	Parking Lot Shoebox
Location:	Parking lots (not including parking on arterial roads)
Type C:	Pedestrian Shoebox
Location:	Tertiary roads and adjacent parking Walkways, sitting areas, plazas, courtyards and pedestrian areas
Type D:	Antique Street Lamps
Location:	Historical Areas— i.e. adjacent to Fort Hill and Tillman These fixtures should not be mixed with other light fixture types



Antique Street Lamp

## Site Design Guidelines

**7.3 SETBACKS**

Setbacks are to be used as a guide in locating fixtures.

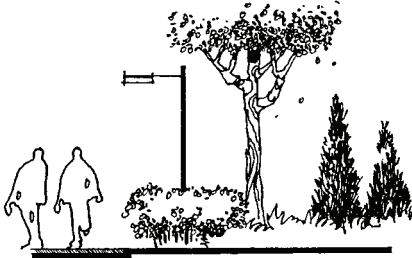

Foliage shall not block light

Location:	Arterial, Secondary, and Tertiary Roads
Set-back:	Determined based on site conditions
Location:	Parking Areas, Parking Spaces and Aisles
Set-back:	4" from edge of paving
Location:	Walkways, Plaza, and Other Pedestrian Paving
Set-back:	2"-6" from edge of paving
Location:	Bikeways
Set-back:	Compatible with surroundings
Location:	Planted Areas
Set-back:	Ensure that plants do not block light If foliage interferes with illumination, plants may be judiciously pruned

**7.4 ILLUMINANCE VALUES**

The following are recommended illuminance values for the average levels of light suitable for the campus:

<u>Location</u>	<u>Minimum Foot Candle</u>	<u>Average Foot Candle</u>
Arterial Roads	1.0	1.6
Secondary Roads	0.5	0.8
Tertiary Roads	0.4	0.7
Parking Lots	1.0	3.0
Walkways and Stairways	1.0	3.0
Pedestrian Plazas	1.0	2.0
Pedestrian Underpasses	4.0	6.0
Bikeways	0.5	0.7

Above are recommendations for average illuminance on the horizontal based on Illuminating Engineering Society of North America guidelines. These values do not represent initial illuminance, but should be in-service values of systems designed with proper light loss factor.

## Site Design Guidelines

- The recommended illuminance values are the minimum and provide visibility only when illumination over roads and walks is relatively uniform.
- In general, arterial roads shall be illuminated only at intersections with other roads, at pedestrian and bicycle crossings and at entrances to parking lots. The exceptions are sections of arterial roads, the western section of Perimeter Road near the stadium, the southern section of Perimeter Road adjacent to the Strom Thurmond Center and SC Highway 93 along Bowman Field.
- The illuminance in the area of road intersections should be the sum of the recommended levels of the intersecting roads.
- Where the walkways or bikeways cross roads either at road intersections or between them, the percent of roadway illuminance should be increased so that the illuminance is 1.5 times to 2 times the level recommended illuminance values. An example would be a pedestrian crossing at an arterial road should have a 2.1 to 2.8 foot candles of illuminance ( $1.4\text{FC} \times 1.5 = 2.1\text{FC}$ ).
- The illuminance in the area of parking lot access roads to arterial and secondary roads should be the sum of the recommended levels of the parking lot and its adjacent access road.
- Where shared use paths occur in a separate corridor, no additional lighting shall be provided.
- To provide well-illuminated surroundings for walkways and pedestrian areas, it is recommended that 8' on each side of the area be lit to levels of at least 1/3 of that suggested for the pedestrian way.

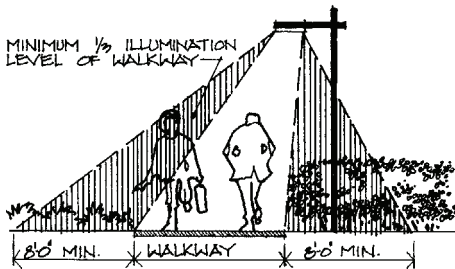

Illuminate Pedestrian Area Surroundings

**7.5 UNIFORMITY**

Uniformity shall be expressed in terms of the average-level-to-minimum point method in which the average illuminance on the lighted surface is divided by the lowest value at any point in the area.

- Using this method the average-level-to-minimum ratio should not exceed:
  - 3 to 1 for Arterial roads
  - 5 to 1 for Tertiary roads, walks, and pedestrian areas

(Refer to IIESNA G-1-03, *Guideline for Security Lighting for People, Property, and Public Spaces*, 2003, Illuminating Engineering Society of North America.)

## Site Design Guidelines

## 7.6 SPACING

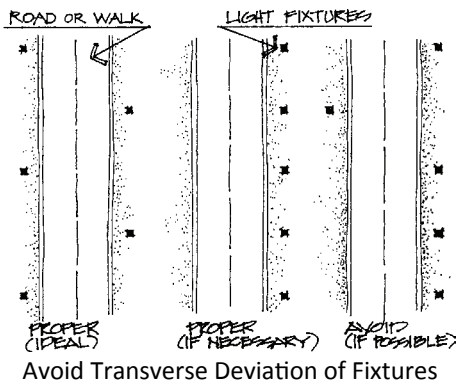

## 7.7 PROCEDURES

- On roadways, placement of individual fixtures may vary up to 20% of the average spacing (10' if the average is 50') as long as no two consecutive placement changes are involved. Transverse deviation of an individual fixture should be made only where there is not other compromise.
- For specific designs that deviate from preferred system layout and non standard spacing requirements, consideration will be given by the University Planning and Design Office in cooperation with University Facilities.
- University Facilities shall keep the University Planning and Design Office informed of scheduled future fixture replacements and coordinate the replacements so they are in context with other planned campus improvements.
- New fixture replacement areas shall be viewed as a whole and separated from the surrounding areas where older fixtures types still exist.
- University Facilities shall be responsible for maintenance of the existing system and making routine bulk and individual fixture replacements.
- If an area requires a considerable amount of maintenance, then University Facilities shall coordinate with the University Planning and Design Office to decide whether or not to replace the existing system with the new type fixtures.
- University Facilities shall provide fixture details and photometric and electrical data to design consultants.
- Lighting specifications are located in the Appendix.



**8.0 INTRODUCTION**

To assist the public in identifying and locating the facilities of Clemson University, an informational signage system must be provided at on-and off-campus facilities. The proper use of signage and campus graphics is essential to orienting motorists, cyclists and pedestrians and to making the campus layout comprehensible to students, faculty, staff and visitors.

**8.1 SIGN GUIDELINES**

The University's signage policy shall:

- Create a way for people to find where they need to go in an efficient and pleasant way that will reflect well on the University.
- Be well-designed and consistent.
- Provide essential information, orientation and cues to allow for informed wayfinding from the edge of campus to a specific building or area of campus.
- Offer an enjoyable experience for visitors and an environment relatively free of visual clutter.
- Provide appropriate information for the pedestrians and cyclists on campus.
- Conform to [Clemson University's Sign Design Guidelines](#).

The signage information system includes campus identification at major entry points, information maps, vehicular directional signs, area identification, building names, building directories, temporary signs and notices, signs for special events and banners.

**8.2 SIGN CLASSIFICATIONS**

- Signs are classified according to their purpose.
- A description of each sign's purpose shall be included in all plans for new facilities.

**A. Outdoor Signs**

1. *Regulatory Signs* give notice of traffic laws and regulations. These are most often located along roads, bikeways and in parking areas.
2. *Warning Signs* call attention to conditions that are potentially hazardous. These include roadway pedestrian crossing and bikeway signs.
3. *Guide Signs* provide location and directional information, often including names of buildings or areas, or instructions for routing to a destination. These are most often located at visitor parking areas, along walkways and bike routes, in plazas and at the entrances to buildings.



Transit Stops Signage



Parking Lot Identification Sign

B. Indoor Signs

- The signage inside a building is as equally important as outdoor signage.
- All elements, such as directories, room names and numbers, should be consistent across the campus, yet appropriate to in scale with the interior spaces.

**8.3 PROCEDURES**

Campus signage shall conform to the designs and standards set forth in the latest edition of the following publications:

1. Clemson University, [Clemson University's Sign Design Guidelines—A Comprehensive Program to Promote Campus Image, Identification, and Wayfinding](#). Clemson, SC., 2009.
2. South Carolina Department of Transportation, [South Carolina Department of Transportation Traffic Engineering Manuals](#).
3. United States Department of Transportation - [Federal Highway Administration, Manual on Uniform Traffic Control Devices](#).

# Site Design Guidelines

## 9.0 INTRODUCTION

The University pedestrian system forms a network that extends throughout the campus. To create unity and cohesion on the campus, materials for walkways shall be limited to a simple palette of two materials, brick and concrete. One exception is recreational pathways for which asphalt is appropriate.

### 9.1 PAVING CHARACTERISTICS

#### A. Size and Scale

- The minimum width of campus walks shall be 6'. The vast majority of campus walks will be wider than 6' to accommodate pedestrian loads during class change.
- The design and placement of paving shall be scaled to fit the character of that area.
- Further guidelines are located in Section 2: Pedestrian Systems and specifications for paving are located in the Appendix.

#### B. Walkway Materials

- For walkways preferred materials are as follows:
  - Concrete is the standard.
  - Brick is the preferred paving material.
  - Concrete accented with brick borders and dividers is the alternate choice.
- Small service walks and walkways connecting parking lots and other facilities on the periphery of the campus to the core of the campus inside of the secondary roads may be paved with concrete, deleting the brick border.
- Brick paving should be used in nodes, plazas, and courtyards.
- Concrete and brick should be used in the academic core; while concrete should be used for service walks.
- Paving specifications are located in the Appendix.

#### C. Brick Walks

- Brick paving shall consist of brick pavers with flush swept joints laid on a soil-cement base and edged with flat brick borders laid in beds of mortar.

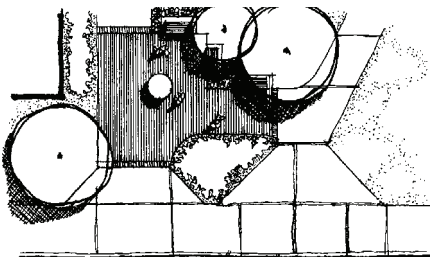

Small Node Paving

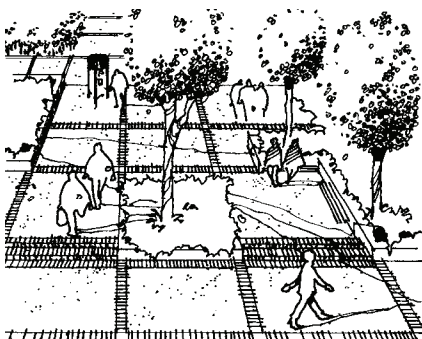

LARGE NODE - BRICK BORDERS & DIVIDERS WITH CONCRETE PAVING. BRICK GREAT WALLS, BRICK STEPS.

## Site Design Guidelines

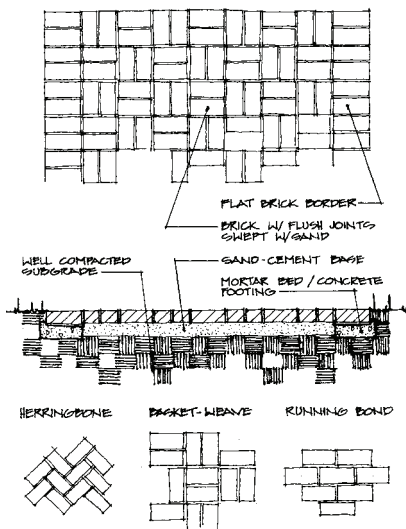

Brick Installation

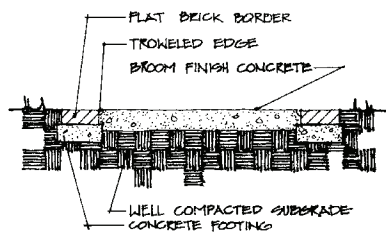
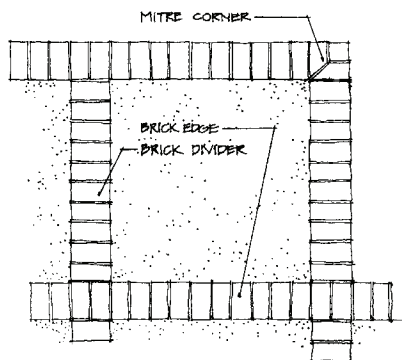

Brick and Concrete

- The brick field may be laid in herring-bone, basket weave, running bond or other patterns. The choice will be predicated on nearby conditions, architectural treatments and the need to provide diversity within an area.
- Where walks are expected to carry maintenance vehicles, brick with flush swept joints shall be laid on a concrete base suitable to carry vehicle loads.
- Brick color, texture and size used for campus paving shall be consistent throughout the campus. The brick is a solid paver in the red-brown range.

## D. Brick and Concrete Paving

- Where concrete and brick are used together, concrete shall be the dominant material and shall be accented with flat brick borders, dividers and trim, such as brick paving under benches.
- Concrete shall be broom finished with troweled edges, construction joints and control joints.
- Where walks are expected to carry maintenance vehicles, deepen the concrete to accommodate vehicle loads.

## Site Design Guidelines

## 10.0 INTRODUCTION

The Clemson University campus, situated on a series of ridges and valleys leading to the old Seneca River Basin, is particularly susceptible to soil erosion and the accompanying sediment buildup in the river basin, and thus presents some challenging siting and grading problems for new facilities. This section presents guidelines for the site work portion of campus improvements that involve the retention of trees and the control of soil erosion and sedimentation. These guidelines recommend ways of reducing maintenance costs while still preserving the quality of the landscape for which Clemson is well known.

## 10.1 GUIDELINES

As a vital aesthetic and functional resource, trees are visual enhancements and contribute to a pleasant learning environment by moderating climate. From an engineering standpoint, they reduce erosion and protect water quality.

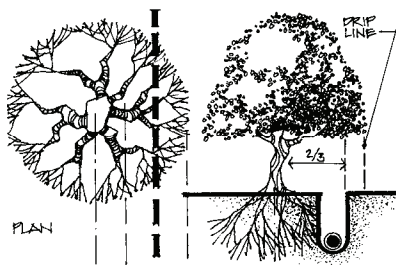

Underground Utilities within  
2/3rds of Drip Line

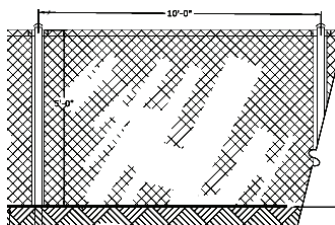

Tree Protection Fencing

- In order to protect trees from damage during construction, tree protection must be addressed prior to final site selection, as the presence of certain trees may preclude selection of certain sites. Guidelines can be found in the [Campus Tree Protection Policy](#) and are referenced further in this Section, 10.5 Procedures. Additionally a consultation with the University Arborist should be considered.
- Before determining underground utility routes, thoroughly inventory the existing trees to determine the most appropriate utility path. When a utility must pass within the inside 2/3rds of a tree's drip line, extreme care should be taken to avoid damage to the roots.
- Avoid cutting or tilling more than 6" within the 2/3rds of a tree's drip line and use tree wells or retaining walls to avoid grade changes around those trees to be retained.
- During construction adhere to the [Campus Tree Protection Policy](#) for guidance, including requirements for barricading so as not to temporarily fill roots.

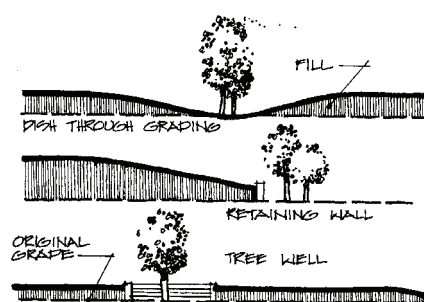

Fill Treatment

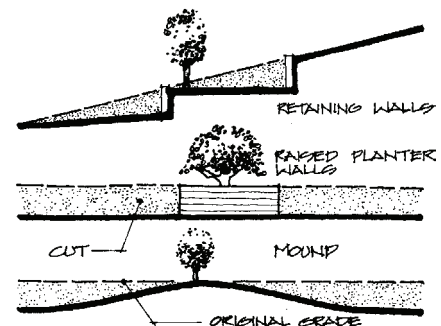

Cut Treatment

## Site Design Guidelines

### 10.2 SOIL EROSION AND SEDIMENTATION CONTROL

#### A. Principles

- Minimize Disturbed Area / Retain and Protect Natural Vegetation
  - Where grade change and removal of vegetation are necessary, keep the size of the area and duration of exposure to a minimum.
  - Critically erodible soil, steep slopes, stream banks and drainage ways should be identified and development planned for minimal disturbance to these vulnerable areas.
  - Plan the development phases so that only the areas which are actively being developed are exposed.
  
- Stabilize and Protect Disturbed Areas As Soon As Possible
  - Stabilize and protect areas where the vegetative cover has been removed or extensive grading has increased the potential for erosion with either vegetative or mechanical control methods.
  - When vegetative cover must be disturbed, stabilize and protect these areas with temporary or permanent measures as soon as possible.
  - Vegetative methods include: Planting of grasses or similar fibrous rooted vegetation to stabilize inadequate protected soil surfaces.
  - Mechanical control methods include: Building of structures such as dams, sediment basins, diversion swales, rip-rap replacement, paving, and/or compacting or roughening soil surfaces.
  - Use temporary measures, including annual grasses, mulches or netting, where disturbed areas will undergo modification during the process of construction.
  - Use permanent measures, including perennial grasses, shrubs, rip-rapped banks and retaining walls, when the stabilization measures will remain in use after construction is complete.

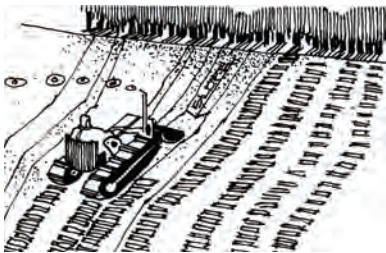

Stabilization of Area by Roughening  
Soil Surface

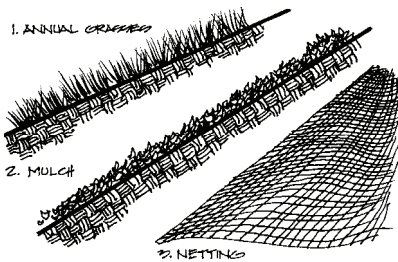

Temporary Stabilization Measures

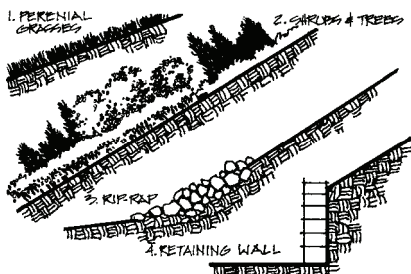

Permanent Stabilization Measures

## Site Design Guidelines

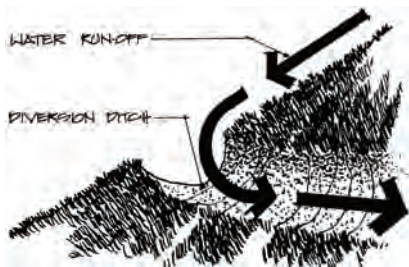

Protect Disturbed Areas by  
Diverting

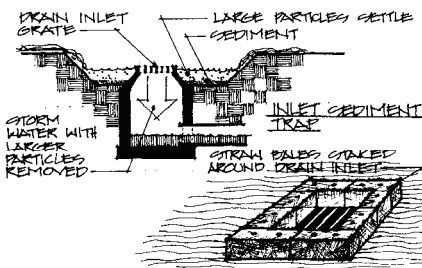

Sedimentation Traps

- Minimize Storm Water Velocity
  - Removal of existing vegetative cover will increase impermeable surface area and lead to both an increase in the volume and velocity of runoff.
  - Short slopes, low gradients, and preserving natural vegetative cover can keep storm velocities low.
  - Either temporary or permanent grade control structures can be used to reduce the velocity of flow in channels and streams. Check dams, weirs and drop spillways (made of a variety of materials) reduce channel grade and dissipate energy of flowing water.
- Divert Storm Water Runoff from Disturbed Areas
  - Divert runoff from slopes that are exposed during development by using diversion methods, such as dikes or ditches, to intercept runoff and direct it away from the slope face. Depending upon the soil conditions and the amount and velocity of runoff diverted, ditches can be bare channels or channels lined with a hard surface material.
- Retain Sediment Within the Site Area
  - To prevent sediment from entering campus streams and waterways, all development projects shall utilize either temporary or permanent sediment control methods such as vegetative filters and sediment traps or basins.
  - Vegetative filters include sod placed around drain inlets to reduce sediment flow into storm drainage pipes.
  - Sediment traps are usually temporary and are removed or filled in after construction. They include straw bales and sandbag check dams and constructed earth sediment traps at drain inlets.
  - Sediment basins consist of earthen dams, mechanical spillways and emergency spillways. Construction of sediment basins should be completed before clearing and grading begins and are generally located near the low point of the site. Their points of discharge must be stabilized. Sediment basins can often become part of the final development of an area, taking the form of a small pond or lake that enhances the campus.

## Site Design Guidelines

## 10.3 SLOPE DESIGN AND TREATMENT

Due to the rolling terrain of the campus, site development involves the creation of slopes to afford grade transition.

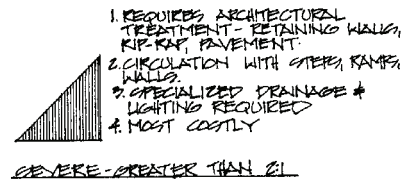
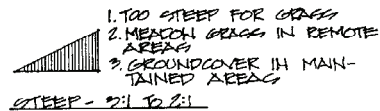
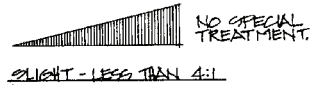

Slope Types

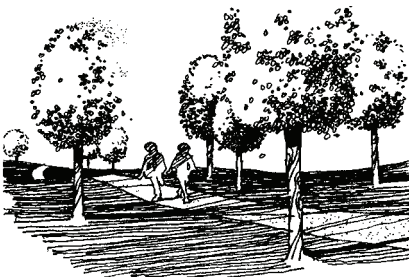

Slight Slope

- Minimize and Balance
  - Slope gradients, which reduce the potential for increased storm water runoff velocities and incur high treatment, maintenance costs and program requirements; with topographic restrictions and design criteria which may demand steeper slopes.
  - Erosion hazards, the length of the slope and the gradient should be kept at a minimum.
- Design Criteria for All Slopes
  - The top and bottom of turfed slopes should have an ample radius to avoid either “scalping” the grass or leaving it uneven.
  - Grades should always slope away from buildings.
  - Whenever possible, utility manholes should be placed at either the top or bottom of slopes. Their covers should be pitched to match the gradient (to a maximum of a 1 to 3 pitch) with the low edge coincident with the ladder rings. Use larger size covers if necessary.
- *Slight Slopes*—less than 1 foot vertical to 4 feet horizontal (25%)
  - Require no special landscape treatment.
  - Pedestrian circulation should be simple without steps or walls unless absolutely necessary. Orient walks parallel with contours.
  - Riding and gang movers may be used safely and efficiently.



## Site Design Guidelines



Moderate Slope



Steep Slope

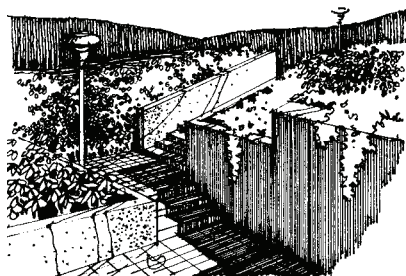

Severe Slope

- *Moderate Slopes*— from 1 foot vertical to 4 to 3 feet horizontal (25% to 33%)
  - Riding mowers reach their limits for safe, efficient moving as the equipment tends to slide and is troublesome to maneuver, especially when grass is wet. North facing slopes, because of lingering dew or subsurface seepage, can delay mowing schedules.
  - Avoid planting single specimen trees and shrubs in grass on these slopes as it is difficult to mow around them.
  - Plant trees in groups that self-mulch and do not require grass or in ground-cover beds that do not require mowing.
  - In areas that do not have trees, use grass where slopes are accessible and groundcovers in areas where moving access is difficult.
- *Steep Slopes*— from 1 foot vertical to 3 to 2 feet horizontal (33% to 50%)
  - The maximum steep slope for landscaping and not for safe and efficient grass mowing, including push mowers.
  - In remote areas, demanding little or no maintenance, use meadow grass seeding that requires no mowing and allows native plants to succeed in these areas.
  - In areas requiring maintenance, use low woody groundcovers that form a mass of roots and crowns that are effective for holding slopes.
  - Trees and shrubs may be mixed with either the naturalizing grasses or with maintained groundcover.
  - Use erosion controls such as jute net or straw mulch to hold soil until the plant roots are established.
  - Avoid long, sustained steep slopes in favor of a combination of moderate and severe slopes. Using the steepest slopes for a short distance allows for a longer slope where more normal construction and maintenance can occur.
- *Severe Slopes*—less than 1 foot vertical to 2 feet horizontal (50%) and steeper
  - Severe slopes are best treated architecturally rather than with landscaping.
  - Plants and ground covers are difficult to establish and require frequent and skilled maintenance to prevent erosion and unsightliness.
  - Treatment with retaining walls for vertical retainment and rip-rap or pavement for sloped retainment is recommended.

## Site Design Guidelines

### 10.4 ENVIRONMENTALLY SENSITIVE STREAMS

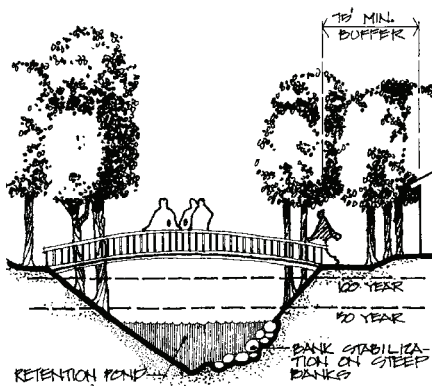

- PROTECT & PRESERVE SLOPE VEGETATION
- PROTECT WATER QUALITY
- BANK STABILIZATION WHERE REQUIRED
- RETENTION POND POTENTIAL
- 75' MIN. SETBACK
- BRIDGE ABOVE 100 YEAR FLOOD
- WALKS ABOVE 50 YEAR FLOOD

- Grass mowing is dangerous and difficult except for lateral distances of 3 feet or less (push mowers only).
- Circulation solutions will require the use of steps, ramps, walls, drainage systems and extra lighting, all of which will require expensive construction and maintenance.
- If these slopes are proposed in any amount, consideration should be given to alternate solutions.

The [2002 Campus Master Plan](#) and [Riparian Corridor Master Plan](#) have established guiding principles for the environmentally sensitive corridor of the Hunnicutt Creek streambed, its tributaries and associated wooded valleys. The streams and associated riparian corridor, or stream side forests, cannot be successfully altered until stormwater from the watershed is controlled in a manner that mimics predevelopment hydrology. A holistic approach is required to reduce stormwater quantity and improve water quality on campus.

#### A. Character

- Riparian corridors are a healthy, safe and stable series of environments.
- They are supportive of the functional needs of research and service needs of the University and provide for the best plant and animal communities native to the region.
- Dedicated open spaces are a critical and important part of the University character and infrastructure.

#### B. Development Guidelines

- Erosion Protection
  - Preserve slope vegetation and direct surface drainage from nearby development away from slopes. This helps to protect slopes and stream banks from erosion.
  - Control upstream erosion and soil sedimentation to maintain stream water quality.
  - Utilize rip-rap, gabions or other bank stabilization treatments to protect steep stream banks from erosion.

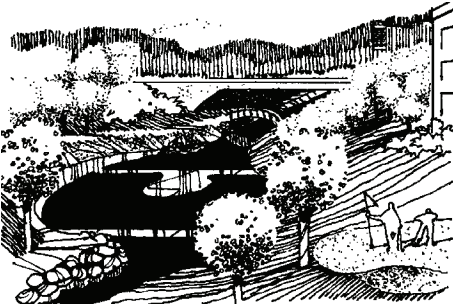

Integrate Retention Ponds with Surroundings

- Impounding
  - Streams may be impounded at intervals to create storm water run-off retention ponds with attention given to the integration of the ponds into their surroundings to create an aesthetically pleasing amenity to campus.
  - Before the decision is made to impound a stream section, studies of the stream water flow characteristics shall be completed, as some campus streams are seasonal and may not provide enough constant water flow to support a year-around pond.
  - Where areas are needed for temporary storm water retention and will not support a permanent pond, then their designs shall consider year around aesthetics so as to be visually pleasing throughout the seasons. Such temporary retention areas may incorporate features such as shallow grassed banks and grass bottoms that appear as lawns, yet serve to store storm water on an occasional basis. These temporary retention areas that are subject to frequent flooding may utilize a stone bottom that is more tolerant than grass to flooding and associated with silt deposits.
- Development of buildings, parking, or other substantial construction shall be set-back from the top of valley slopes (or streambeds where adjacent slopes are not significant) a minimum of 75' and a vegetative buffer created using existing or added trees and grasses.
- Walks and bridge crossings shall be constructed above the 100 year flood elevation.

**10.5. PROCEDURES**

A. Plans

- All plans for campus improvements including, buildings, roads, parking areas, walkways, plazas, overhead and underground utilities and other improvements that require clearing vegetation or grading the land, shall be submitted through University Facilities to the University Planning and Design Office for approval.
- These plans shall:
  - Be submitted regularly during the preparation of design documents, starting with schematic plans, and shall follow through the completion of construction documents.

- Outline design features and measures that will be taken to retain existing healthy and mature trees, control soil erosion and sedimentation during and after construction.
- Be designed to blend with existing topographic, soil and vegetative characteristics with a minimum of clearing and grading.
- Indicate existing trees that will remain and those that will be removed, as well as modifications to existing grades.

B. Siting

- Before construction begins, proposed facilities shall be staked in the field to indicate layout and grades. These shall then be reviewed by Campus Facilities and the University Planning and Design Office and adjustments to improve siting shall be made if deemed necessary.

C. Campus Tree Protection Policy

- Tree protection must be addressed prior to final site selection, in design, pre-construction planning and throughout the construction period.
- The procedures appended in the policy must be incorporated into all project plans and specifications regardless of scope, size or location of the project to ensure tree health and survivability.
- When construction or disturbance of a site on campus is envisioned, a complete site survey including the location of utilities, trees, future building sites and future utilities will be completed by the Campus Facilities survey group.
- After final selection of site, a tree survey shall be submitted by the Campus Arborist to the Project Manager listing tree sizes and species. This survey will be an extension of the original site survey.
- A tree protection plan shall be submitted with other drawings as part of the overall project approval process. Proper tree protection procedures are to be followed. For procedures refer to the [Campus Tree Protection Policy](#).

- 11.0 INTRODUCTION** The University's parking lots serve the needs of resident and commuter students, faculty, staff and visitors. This section offers guidelines for parking lot size, landscaping, and other aesthetic requirements, while the [2002 Campus Master Plan](#) outlines locations for these facilities.
- 11.1 GUIDELINES** A parking lot shall be defined as a paved area existing primarily for motor vehicle parking, located entirely off-street and affording ingress and egress for vehicles. These guidelines do not apply to roadside parking, such as parallel parking on secondary roads or tertiary roads, which are located in Section 3: Vehicular Systems.
- 11.2. PARKING LOTS** Parking lots should be considered according to the following criteria:
- Their size in relation to the facilities they serve and to site limitations such as: available space, topography and storm drainage capacity.
  - Their size shall be as small as is practical for the situation.
  - The scale of lots related to their surroundings and the visual and aesthetic aspects of the facility.
  - Where very large parking areas are required, the lots shall:
    - Be designed as a series of smaller areas providing parking spaces.
    - Separated by areas planted in trees and grass.
    - Provide a minimum of 40' separation between the lots.
    - Shall contain the number of trees appropriate to the lot as outlined in following Section 11.5 Landscaping and Visual Screen Planting .
- 11.3 HANDICAPPED ACCESSIBILITY**
- Parking lots shall incorporate an appropriate number of handicapped parking spaces per the requirements of the [Americans With Disabilities Act](#).
  - Parking spaces for disabled people shall be located on the shortest possible accessible circulation route to an accessible entrance of a particular building or the area of campus the lot serves.

Handicapped Parking Guidelines

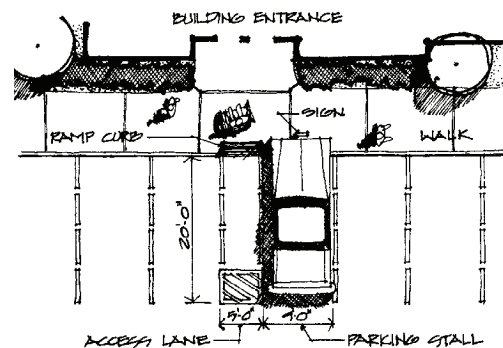

## Site Design Guidelines

**11.4 PARKING DIMENSIONS**

## Minimum Space and Aisle Dimensions

- Residential student storage lots  
Spaces: 8'6" x 18'      Aisle width: 24'
- Commuter students, staff and visitor lots  
Spaces: 9' x 18'      Aisle width: 24'
- Motorcycle  
Spaces: 5' x 11'
- Handicapped  
Spaces: 9' x 18' with an adjacent 5' wide access aisle.  
For van accessible: Spaces adjacent access aisle should be 8'.  
The access aisle shall be part of an accessible route incorporating curb ramps and maneuvering space required to meet accessibility and the requirements of the [Americans With Disabilities Act](#).

**11.5 LANDSCAPING AND VISUAL SCREEN PLANTINGS**

Parking lots shall be designed to incorporate large deciduous trees, groundcover and grass and visual screen plantings to enhance the aesthetics of the campus environment and reduce the impact on adjacent roads, buildings and open spaces. Trees placed within the interior of parking lots are required to assist in reducing heat island effects and to create a pedestrian scale.

## A. Landscaping

- Deciduous trees:
  - Provide shade in the summer.
  - Reduce ice film in the winter by allowing the sun to heat the pavement.
  - Help make parking lots an aesthetic asset to the campus.
  - Shall have a minimum setback of 4' from back of curb.
  - Shall be under planted with groundcover and/or mulch.
- Trees shall be located in curbed medians (with a minimum width of 10') or curbed islands (with a minimum width of 9').
- Parking lot islands that are subject to high pedestrian traffic shall be paved with flush brick on a sand base (instead of grass or groundcover). These islands may have trees with brick on sand (not sand cement) placed under the tree adjacent to the trunk.
- A maximum of 12 parking stalls will be allowed between tree islands.

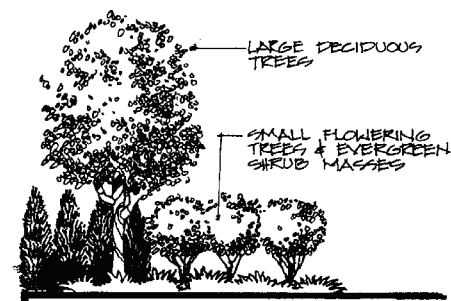

Screen Vegetation

## Site Design Guidelines

- When planning to add trees to existing parking lots, assess the number of spaces to be deleted and consider reducing the width of remaining spaces to the minimum size allowed.
- Connect all parking lots to the facilities they serve with ample pedestrian walks and lighting. See Section 2: Pedestrian Systems and Section 7: Site Lighting for further specifications.
- All signs, light fixtures, fire hydrants and other items subject to damage by vehicle bumper shall be set back a minimum of 4' from the back of curbs.
- Maximum Number of Parking Spaces Per Tree In Lots

<u>Lot</u>	<u>Maximum Space Per Tree</u>
Residential Student/Storage Lot	20
Commuter Student	15
Faculty Staff and Visitor	10

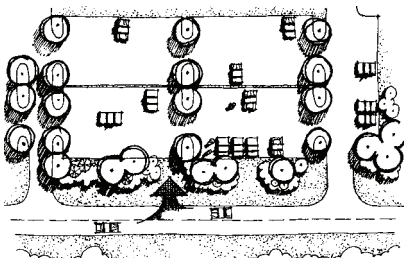

Screen Planting

## B. Visual Screen Plantings

- Shall consist of large deciduous trees, small flowering trees and masses of evergreen shrubs arranged informally.
- Shall have openings between the masses at random intervals and shall not be so dense as to preclude the opportunity for surveillance of the lot by campus security and passersby from surrounding roads. These openings shall not exceed 33% of the screen.

## 11.6 MOTORCYCLE PARKING

## Motorcycle/Scooter Parking Spaces

- Shall be provided in all lots located close to dormitories and walks that connect the main lot to the buildings they serve.
- Will be highly visible and easy for campus security to patrol.
- Located such that maneuvering cycles in and out of spaces does not interfere with automobile traffic.

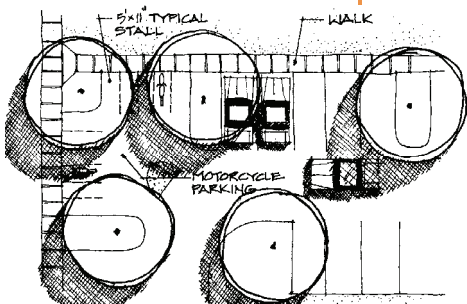

Motorcycle Parking

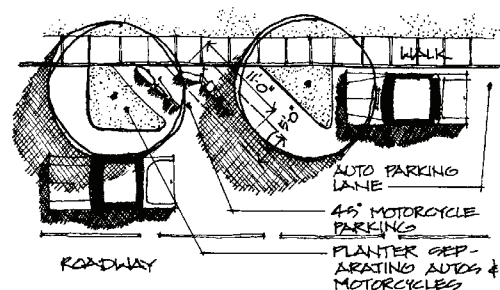

Motorcycle Parallel Parking

**PUBLICATIONS REFERENCED**[Hyperlinks Available](#)

These publications are referenced in various sections of the Site Design Guidelines.

AASHTO, [1999 Guide for the Development of Bicycle Facilities](#). 1999.

City of Greenville, [City of Greenville Bicycle Master Plan Design Guidelines](#). 2001.

Clemson University, [Campus Tree Protection Policy](#). 2005.

Clemson University, [Clemson University Bikeway Design Guidelines](#). 2012.

Clemson University, [Clemson Master Plan—Clemson University 2002](#). 2002.

Clemson University, [Clemson Master Plan—Clemson University 2002: Design Principles, Design Guidelines, Planning Standards](#). 2002.

Clemson University, [Clemson University's Sign Design Guidelines—A Comprehensive Program to Promote Campus Image, Identification, and Wayfinding](#). 2009.

Clemson University, [Design Guidelines Report for the Clemson University Comprehensive Master Plan](#). 1995.

Clemson University, [Riparian Corridor Master Plan](#)., 2006.

Clemson University, [Sustainability Action Plan](#). 2010.

Clemson University, [Sustainable Green Building Policy](#). 2005.

Illuminating Engineering Society of North America, [Illuminating Engineering Society of North America Guidelines](#).

Illuminating Engineering Society of North America, [IESNA G-1-03, Guideline for Security Lighting for People, Property, and Public Spaces](#). 2003.

NACTO, [National Association of City Transportation Officials Cities for Cycling Urban Bikeway Design Guide](#). 2011.

South Carolina Department of Transportation, [South Carolina Department of Transportation Traffic Engineering Manuals](#). 2011.

United States Department of Justice, [A Guide to Disability Rights Laws, Americans with Disabilities Act /Rehabilitation Act Section 504](#):. 2009.

United States Department of Transportation, [2004 Characteristics of Emerging Road and Trail Users and Their Safety](#). 2004.

United States Department of Transportation - [Federal Highway Administration, Manual on Uniform Traffic Control Devices](#). 2009.

United States Department of Transportation, [FHWA Designing Sidewalks and Trails for Access Part II of II: Best Practices Design Guide](#). 2001.



**ACKNOWLEDGEMENTS**

**Clemson University Planning and Design Office**

**Graduate Students**

Erika Mueller	Graduate Assistant
Victoria Wright	Graduate Assistant

**Planning Staff**

Gerald Vander Mey	Director, University Planning and Design
Barret Anderson	Landscape Architect
Tanya DeOliveira	Planner

**INTRODUCTION**

It is a goal of the University to establish campus wide, sustainable standards that demonstrate the University's commitment to environmental, economic and social stewardship. These standards help to achieve a coherent appearance for outdoor spaces; ensure a minimum standard of quality and maintainability; promote environmental quality, economic vitality and social benefit through design. More information regarding sustainable building practices is located in the University's [Sustainable Building Policy](#).

The products listed below have been adopted as the official products to be used by the University. Substitutions are not to be allowed without prior written approval from the University Planning and Design Office. Following this appendix are detailed specification sheets.

**PEDESTRIAN SYSTEMS**

- **Emergency Phone**

Manufacturer:

Security Telephone

115 Railroad Ave.

Johnston, RI 02919

[www.ramtel.com](http://www.ramtel.com)

Product: Stainless Steel Column

Model No.: PLC-9

Frame Finish: Dark Brown

Product: Security Telephone—One Button Auto Dial

Model No: RR733

**VEHICULAR SYSTEMS**

- None

**BICYCLE SYSTEMS**

- **Bicycle Racks**

Manufacturer:

Landscape Forms

431 Lawndale Ave.

Kalamazoo, MI 49048

[www.landscapeforms.com](http://www.landscapeforms.com)

Product: Bola Bike Rack

Model No's.: 2175-4,5,6,7,8,9,10

Frame Finish: Stormcloud

Mounting: Will vary based on site requirements

## SITE FURNISHINGS

- **Ash Buttler**

Manufacturer:

Forms + Surfaces™

6395 Cindy Lane

Carpinteria, CA 93013

[www.forms-surfaces.com](http://www.forms-surfaces.com)

Product: SUBUT-LGS

(Large Buttler, Dark Brown), pole mount

- **Benches**

General Campus Applications

Manufacturer:

DuMor™

Mifflintown, PA

[www.dumor.com](http://www.dumor.com)

Product: Bench 39, Model # 39-60D

Bench 37 (backless), Model # 37-60D

Frame Finish: Bronze

Slat type: Douglas Fir

Mounting: Will vary based on site requirements

Historic District Applications

Manufacturer:

Columbia Cascade Company

1975 SW Fifth Avenue

Portland, OR 97201-5293 U.S.A.

[www.timberform.com](http://www.timberform.com)

Product: TimberForm® Restoration series

Model No.: 2118-6 six feet long, with armrests

Frame Finish: Dark Bronze

Slat type: Purple Heart wood

Mounting: Will vary based on site requirements

**SITE FURNISHINGS**

- **Bollards**

Available in 3 sizes:

Manufacturer:

Clemson Campus Facilities

Sizes: 2 1/4" diameter

4" diameter

6" diameter

Finish: Dark Duranodic Bronze

- **Bus Stop Shelters**

Manufacturer:

Landscape Forms

431 Lawndale Ave.

Kalamazoo, MI 49048

[www.landscapeforms.com](http://www.landscapeforms.com)

Product: Kaleidoscope Series

- **Table/Chairs**

Manufacturer:

Landscape Forms

431 Lawndale Ave.

Kalamazoo, MI 49048

[www.landscapeforms.com](http://www.landscapeforms.com)

Product: Carousel Table with 4 backed seats

Seats: Metal grid

Tabletop: Marneaux w/umbrella hole

Finish: Verde Green, Silver, Stone, Titanium, Stormcloud

Optional Accessory:

Product: Solstice Altair Sun Shade (Perforated Panels)

Finish: Verde Green, Silver, Stone, Titanium, Stormcloud

- **Handrails & Guardrails**  
*See specification sheet*
- **Trash Receptacles**  
Manufacturer:  
Victor Stanley, Inc.  
P.O Drawer 330  
Dunkirk, MD 20754  
[www.victorystanley.com](http://www.victorystanley.com)  
Product: 36 Gallon Litter Receptacle  
Ironsites Series  
Finish: Dark Bronze
- LIGHTING** • **Antique Lighting**  
Manufacturer:  
Antique Street Lamps  
One Lithonia Way  
Conyers, GA 30012  
[www.antiquastreetlamps.com](http://www.antiquastreetlamps.com)  
Product: Acorn luminaire (AAT23) lamp  
Austin series post (single lamp)  
A series luminaire base  
  
Note: Post material are offered in cast iron and aluminum. Cast iron should be used in Historic District.
- **Shoebox Lighting**  
Manufacturer:  
Spaulding Lighting  
701 Millennium Drive  
Greenville, SC 29607  
[www.spauldinglighting.com](http://www.spauldinglighting.com)  
Product: Newark Series Fixture  
Type A: Roadway  
Type B: Parking Lot  
Type C: Pedestrian  
  
Product: Anchor Base

## Site Design Guidelines

- LIGHTING** See: Clemson University, [Clemson University’s Sign Design Guidelines—A Comprehensive Promote Campus Image, Identification, and Way Finding](#). Clemson, SC., 2009
- PAVERS**
- **Brick**

Manufacturer:

Pine Hall Brick  
2701 Shorefair Drive  
Winston- Salem, NC 27116-1044  
[www.pinehallbrick.com](http://www.pinehallbrick.com)

Product:

Type 1: English Edge Red without grouted joints & beveled edges with spacer nibs.

Type 2: Pathway Red with grouted joints

Type 3: Pathway Red without grouted joints
  - **Concrete**

Typical sidewalks  
4,000 psi  
6 inches thick  
Welded wire mesh (optional)
  - **Tactile Warning Surface**

Manufacturer:

Unilock Chicago  
301 East Sullivan Road  
Aurora, IL 60505  
[www.unilock.com](http://www.unilock.com)  
OR comparable

Finish: Charcoal

Size: 11.79” x 11.79” x2.75”
- SITE WORK**
- **Tree Protection Fencing**

5’-0” high chain link fence, with appropriate signage directly attached to fence at regular intervals (see specifications details)

Reference the [Campus Tree Protection Policy](#) for tree protection guidelines

**VEGETATION SYSTEMS****Campus Tree List**

Following is a guide to the types of trees permitted on campus. Trees you wish to specify in your project that is outside of this list must be approved by University Planning & Design Office.

Minimum allowable Planting Sizes:

Shade trees – 4” caliper

Street trees – 4” caliper

Flowering trees – 3” caliper

Evergreen trees – shall be branched to ground with minimum height of 8’

Screen trees – shall be branched to ground with minimum height of 8’

Evergreen and Screen Trees:

1. Cedrus deodara – Deodar Cedar
2. Ilex x attenuata – Foster’s Holly
3. Ilex x ‘Emily Bruner’ – Emily Bruner Holly
4. Ilex ‘Nellie R. Stevens’ – Nellie R. Stevens Holly
5. Ilex opaca – American Holly
6. Tsuga canadensis – Hemlock

Lawn Trees

1. Acer saccharum – Sugar Maple
2. Acer rubrum – Red Maple
3. Aesculus x carnea – Red Horsechestnut
4. Aesculus octandra – Yellow Buckeye
5. Betula nigra ‘Heritage’ – River Birch
6. Carpinus betulus – American Hornbeam
7. Carya ovata ‘Shagbark Hickory’ – Shagbark Hickory
8. Fagus grandifolia – American Beech
9. Fagus sylvatica – European Beech
10. Ginkgobilobia ‘Autum Gold’ – Ginkgo
11. Gymnocladus dioica – Kentucky Coffee tree
12. Liquidambar styraciflua ‘Rotundiloba’ – Sweetgum (fruitless)
13. Liriodendron tulipifera – Tulip Poplar

14. *Magnolia acuminata* – Cucumbertree Magnolia
15. *Nyssa sylvatica* – Black Tupelo
16. *Plantanus occidentalis* – American Sycamore
17. *Quercus acatissima* – Sawtooth Oak
18. *Quercus alba* – White Oak
19. *Quercus coccinea* – Scarlet Oak
20. *Quercus hemisphaerica* – Darlington Oak
22. *Quercus imbricaria* – Shingle Oak
23. *Quercus macrocarpa* – Bur Oak
24. *Magnolia grandiflora*- Southern Magnolia
25. *Quercus palustris* – Pin Oak
26. *Quercus phellos* – Willow Oak
27. *Quercus robur* – English Oak
28. *Tilia cordata* – Littleleaf Linden

#### Columnar Trees

1. *Acer Rubrum* ‘Armstrong’ - Red Maple
2. *Acer Rubrum* ‘Columnare’ - Red Maple
3. *Acer Rubrum* ‘Red Rocket’ - Red Maple
4. *Acer Saccharum* ‘Endowment’ – Sugar Maple
5. *Acer Saccharum* ‘Greencolumn’ - Sugar Maple
6. *Acer Saccharum* ‘Newton Sentry’ - Sugar Maple
7. *Carpinus betulus* ‘Columnaris’ - European Hornbeam
8. *Carpinus betulus* ‘Fastigiata’ - EuropeanHornbeam
9. *Carpinus betulus* ‘Franz Fontaine’ - European Hornbeam
10. *Quercus robur* ‘Regal Prince’ - English Oak
11. *Quercus robur* ‘Rosehill’ - English Oak
12. *Quercus robur* ‘Skyrocket’ - English Oak



Street Trees

1. *Acer rubrum* – Red Maple
2. *Acer saccharum* – Sugar Maple
3. *Liquidambar styraciflua* ‘Rotundiloba’ – Sweetgum (fruitless)
4. *Platanus x acerifolia* ‘Bloodgood’ – London Planetree
5. *Quercus nigra* – Water Oak
6. *Quercus nuttallii* – Nuttall Oak
7. *Quercus phellos* – Willow Oak
8. *Quercus rubra* – Red Oak
9. *Tilia cordata* – Littleleaf Linden
10. *Ulmus parvifolia* ‘Emer II’ – Allee Elm

Flowering and Small Scale Trees

1. *Acer buergeranum* – Trident Maple
2. *Acer palmatum* – Japanese Maple
3. *Amelanchier* species & hybrids – Serviceberry
4. *Cercis canadensis* – Redbud
5. *Cladrastis kentukea* – Yellowwood
6. *Cornus florida* – Flowering Dogwood
7. *Cornus kousa* – Kousa Dogwood
8. *Crataegus viridis* ‘Winter King’ – Winter King Hawthorn
9. *Koelreuteria paniculata* – Goldenrain tree
10. *Magnolia x soulangiana* – Saucer Magnolia
11. *Magnolia stellata* – Star Magnolia
12. *Magnolia virginiana* – Sweetbay Magnolia
13. *Oxydendrum arboreum* – Sourwood
14. *Prunus x yedoensis* – Yoshino Cherry

## PLC-9 Non Rusting Stainless Steel Column 10" Square with Radius Corners



### Unit includes two lights:

- Combination Constant ON and Strobe  
Strobe Light- One million candle power.  
Housed in a blue Fresnel LEXAN Polycarbonate lens  
Light is protected by a Clear Dome cover and mounted on top of column.

Strobe Flashes when Emergency call button is pressed and stops flashing when called party hangs up.

- Phone Panel Light- 5 Watt Fluorescent. Makes phone visible for easier use.

Options: Built in heater, Cellular Package, Covert camera

### General Specifications of PLC-9 Column

Non Rusting, Non Magnetic Stainless Steel - .125" Thick

Dimensions: 8 ft. High - 10" Square

Phone is recessed 2"

Pre-wired and assembled

Vandal resistant and weatherproof

Graffiti resistant

Lettering 4 sides column.

Weight: 165 pounds

Mounting: (4) 5/8" x 16" "J" bolts

### Wiring:

Units are pre-wired in separate conduit for telephone line and 120 Volts AC power

Operating Voltage Option:

24 Volts AC to 440 Volts AC.

Panel on back of unit provides access to electronics and wiring.

Finish: Powder coated

Standard Colors: Midnight Blue, Architect Brown,  
Forest Green, Safety Red, Black,  
Safety Yellow, White

Custom colors available.

Optional Finish: Natural Stainless - glass beaded finish

## Model RR733 One Button Auto-Dial

Return to [Security Telephones](#)

As part of your analog phone system, the One Button Hands Free Phone provides two way communications for Emergency Assistance. If line is busy or no answer, phone can dial up to three numbers. The MPBP (Micro Processor Based Phone) is designed to meet the needs of changing times and increasing requirements. Ramtel specializes in Custom Silk Screening individualized to your needs.



The One Button Hands Free Phone is designed for indoor or outdoor use.

Phone can be installed in a surface or flush mounted enclosure, wall unit or free standing unit.

What better way to distinctively identify your security telephone than with Custom Silk Screened name and logo.

Many of our customers have asked us to display their custom phone at the various trade shows we have exhibited. We are taking this opportunity to invite you to display your phone panel on our [Custom Silk Screening](#) Web page.

### Telephone Features

- EEPROM Non Volatile Memory
- Password protected remote programmable
- Custom Silk Screened Phone Panel
- Louver Design, Anodized Aluminum Panel (3/16" Thick)
- PIEZO Switches (2" Palm Button Option)
- Weatherproofed speaker and microphone
- Tamper resistant screws and special tool
- Weather Resistant - Vandal Resistant
- Low Voltage Heater Option
- Conformal Coated Electronics
- [Surge and Grounding Protection](#)
- [Condensation Protection](#)

### Functions

- Auto-Redial of Additional Numbers, If line busy or no answer.
- Emergency Call in Progress Cannot be terminated.
- Auto-Answer feature allows for call back and monitoring of area.
- Voice and location identification signal.

- *ADA Compliant:*
  - a) *"Red" indicator light automatically activated when any button on Ramtel phone is pressed, and changes to "Green" when call is answered.*
  - b) *Braille Plaque includes International Phone Symbol.*
- *Phone Diagnostics include: Emergency and Manual Button, LED, Microphone & Speaker (Use with computer software system Reliance 2003)*
- *Disconnect Functions:*
  - a) *Automatic Shut-Off*
  - b) *Remote Shut-Off*
  - c) *Adjustable Time Out Functions*
- *Emergency button external output control. (i.e. Blinking or Flashing Strobe)*
- *Six miscellaneous [External Output Control](#) capability.*  
*(Activated by keypad and Controlled by called party, i.e. release door/gate, turn on and control a top mounted surveillance camera).*

Applications: Walkways, Parking Lots and Garages,  
Escort Service or Assistance, School Playgrounds and  
Athletic Fields, ATM Machines, Police Call Phones,  
Hospitals, Information Centers, Elevators.

Ramtel phones service: Universities & Colleges,  
Schools, Police Departments, Banks, Hospitals,  
Business Complexes, Industrial Developments,  
Shopping Centers, Public Areas.



Embedded

**HANDLE WITH CARE!** Bola's finish can be scuffed by contact with tools, concrete, or other abrasive surfaces. Protect the finish from damage during installation. Use touch-up paint to repair any powder coat finish abrasions.

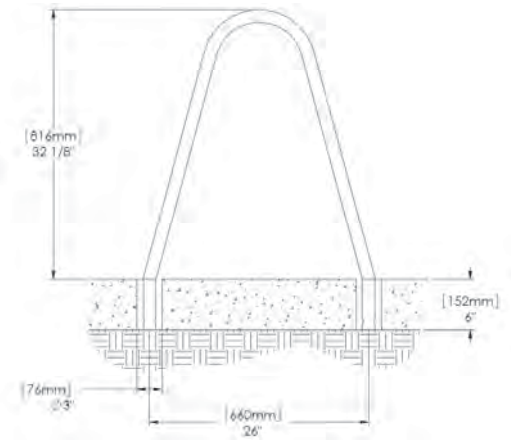

Side Elevation, showing core drill sizes

**Tools Required**

- Unit ships assembled

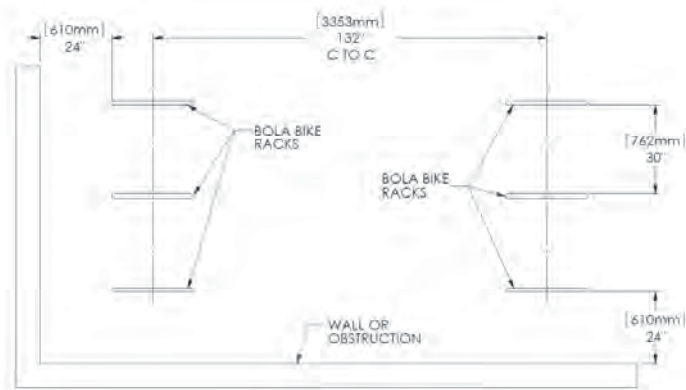

Recommended spacing, according to Association of Pedestrian and Bicycle Professionals (APBP)

- INSTALLATION:**
1. Core drill 3" diameter (minimum) holes 6" deep.
  2. Prepare the holes for outdoor anchoring cement, such as Kwixset™ or Super Por-rok®. Follow the manufacturer's instructions for blowing out dust, filling with water, scrubbing, and removing excess water.
  3. Place the bike rack back into position and fill the holes with anchoring cement.

**BUTTLER® ASH RECEPTACLES**toll free 800.451.0410 • [www.forms-surfaces.com](http://www.forms-surfaces.com)

tech brief

**Buttler®** ash receptacles acknowledge society's changing views towards smoking by offering an aesthetic and discreet solution for the disposal of cigarette butts. Unlike exposed-sand containers, the Buttler conceals discarded cigarettes, keeping the unsightly well out of sight. Buttlers are made for easy servicing and include an internal gasket to inhibit smoldering.

**Available Sizes, Dimensions and Capacities****Medium Buttler**

The medium Buttler is 4.5" in diameter x 11.88" tall with a capacity of approximately 150 cigarette butts.

**Large Buttler**

The large Buttler is 6" in diameter x 16.75" tall with a capacity of approximately 475 cigarette butts.

**Construction**

Buttlers consist of an extruded aluminum cylinder, two cast aluminum end caps and mounting accessories that vary with the mounting option specified (see below). Cigarette butts are deposited in the Buttler through a 2.5" x 1" oval-shaped opening in the upper casting. A grooved inner wall assists in extinguishing cigarettes and discourages the placement of conventional litter in the Buttler.

**Mounting Options****Pole Mount**

The pole mount Buttler is supplied with a 48" high mounting pole that can be fixed to concrete surfaces or any other suitable flat substrate. Poles are made from 2.50" diameter tubular powdercoated stainless steel and include a 6" diameter stainless steel base plate for surface mounting.

**Wall Mount**

The wall mount Buttler is supplied with a bracket that allows the Buttler to be mounted to walls or any other suitable vertical surface. Brackets are made from tubular powdercoated stainless steel.

**Strap Mount (Medium Buttler only)**

The strap mount Buttler is supplied with a bracket and strapping system that allow the Buttler to be quickly attached to existing lampposts, street signs or similar vertical supports. Bracket and straps are all made from stainless steel.

**Litter & Recycling Receptacle Mount (Medium Buttler only)**

An additional bracket is available that allows the Buttler to be attached to the side of Forms+Surfaces litter and recycling receptacles such as Urban Renaissance and Paseo. Prep for the Buttler must be specified at the time your litter or recycling receptacle order is placed. Please call for additional information.



# BUTTLER® ASH RECEPTACLES

toll free 800.451.0410 • www.forms-surfaces.com

tech brief

## Finish Options

### Cylinder

Standard cylinder finishes are Black Anodized aluminum, Clear Anodized aluminum and Evergreen Gloss powdercoat.

### End Caps

Standard end cap finishes are Black Texture, Bright Silver and Evergreen Texture powdercoat.

### Poles, Wall Brackets, Strap Brackets

Standard finish for poles, wall brackets and strap brackets is Black Texture powdercoat.

Different colored Buttler components may be mixed and matched as desired. In addition to the standard finishes outlined above, optional powdercoat colors from the Forms+Surfaces color chart and custom RAL colors are available for all components. Please call or visit our web site for a color chart and for further information on custom color options.

## Graphics

The cigarette graphic is applied in either white or black depending on cylinder color. Custom graphics are available; please call for further information.

## Complementary Products

Forms+Surfaces offers a comprehensive range of litter receptacles, site furniture and other innovative products for architectural and landscape environments. Call us to discuss how the Buttler can be made part of an integrated design package.



## Servicing

The Buttler's lower casting incorporates a key-operated security latch to prevent unauthorized access. Turning the key allows the cylinder to be lowered and removed for emptying. Maintenance instructions are provided.

## External Cleaning

Stains or spotting caused by cigarettes can be removed using a biodegradable cleaner/degreaser such as Simple Green®. Avoid the use of abrasive cleaners.

## Environmental Considerations

The Buttler's aluminum components have a 95% recycled content. Powdercoat finishing produces minimal amounts of VOCs compared to solvent-based finishes. All Buttler components are fully recyclable.



Forms+Surfaces is a member of the U.S. Green Building Council

## Net Pricing and Ordering Information

model	description	net price
SUBUT-MDS	Medium Buttler, standard colors, pole mount	\$299
SUBUT-MDW	Medium Buttler, standard colors, wall mount	\$262
SUBUT-MDB	Medium Buttler, standard colors, strap mount	\$262
SUBUT-MDR	Medium Buttler, standard colors, receptacle mount	\$262
SUBUT-LGS	Large Buttler, standard colors, pole mount	\$353
SUBUT-LGW	Large Buttler, standard colors, wall mount	\$319
Optional powdercoat color from Forms+Surfaces standard color chart		add \$175 per color per order
Custom RAL powdercoat color		add \$450 per color/per order
<b>To order specify:</b> Quantity, model number, cylinder finish, end cap finish and pole or wall bracket finish. <b>Lead time:</b> 4 to 5 weeks after receipt of written approvals for standard finishes; 6 weeks for custom colors. Pricing does not include freight. Shipment is FOB Carpinteria, CA.		

All dimensions are nominal. Specifications and pricing subject to change without notice. For the most current version of this tech brief please refer to our web site at www.forms-surfaces.com.

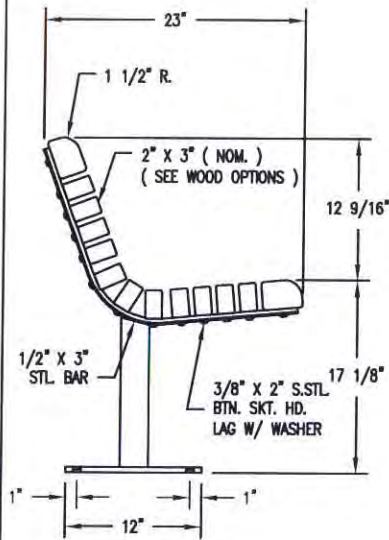

S-2 SURFACE

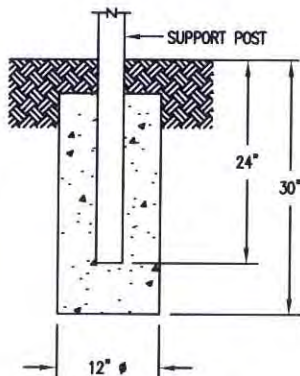

S-1 EMBEDMENT

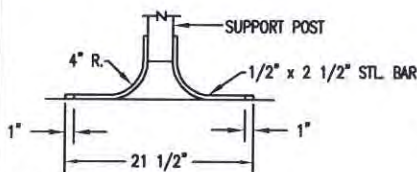

S-3 GULL WING

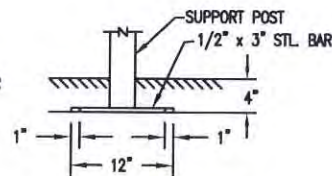
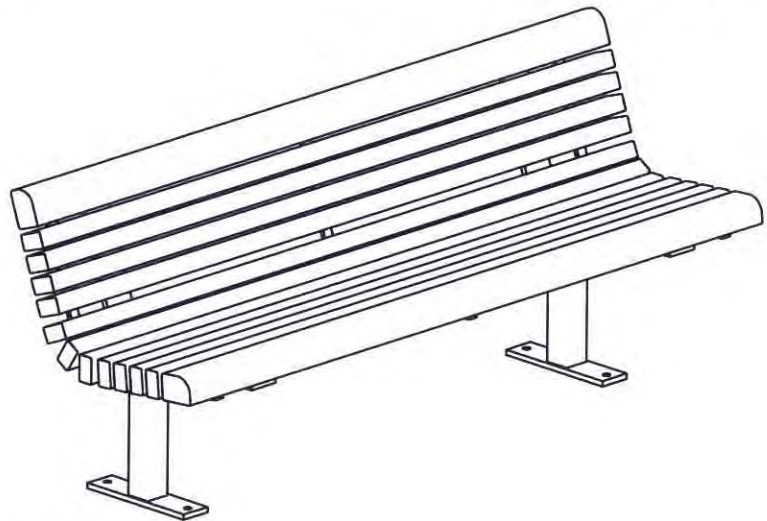
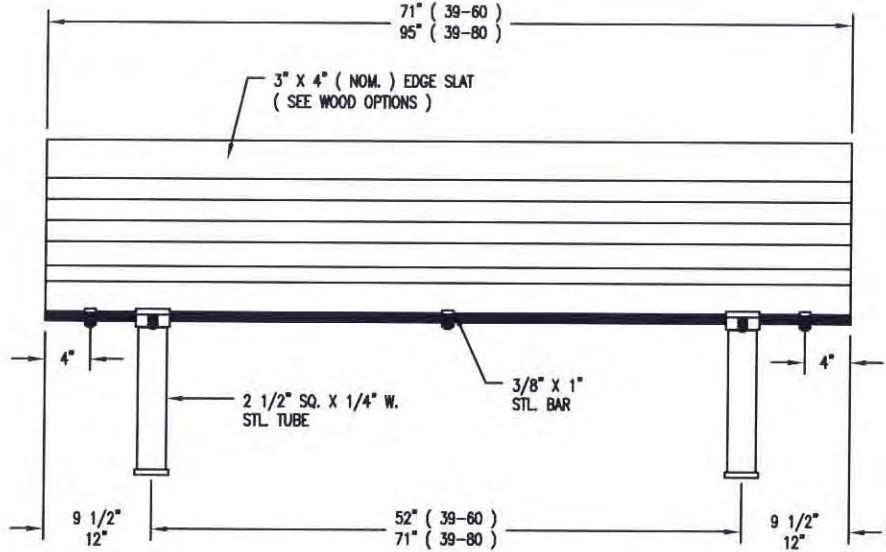

S-4 SUB FLOOR

LENGTH OPTIONS

- 6' BENCH
- 8' BENCH

NOTES

- 1.) ALL STL. MEMBERS COATED W/ ZINC RICH EPOXY THEN FINISHED W/ POLYESTER POWDER COATING.
- 2.) ALL WOOD MEMBERS TREATED W/ CLEAR PRESERVATIVE.
- 3.) 1/2" X 3 3/4" PLTD. EXPANSION BOLTS PROVIDED FOR S-2, S-3 & S-4 OPTIONS.

WOOD OPTIONS

- CLEAR ALL HEART REDWOOD S4S EE
- 'C' & BTR. DOUGLAS FIR KD S4S EE
- CLEAR WESTERN RED CEDAR S4S EE
- OTHER \_\_\_\_\_

  
**DuMor, inc.**  
 P.O. Box 142 Mifflintown, PA 17059-0142

SCALE : NONE  
 DATE DRAWN : 3/24/94  
 DRAWN BY : AH  
 DATE REV. : 10/18/99  
 REV. BY : JSB

TITLE : BENCH  
 REV. C  
 DRAWING NUMBER 39 SERIES  
 SHEET 1 OF 2



SURFACE MOUNT  
OPTION SHOWN

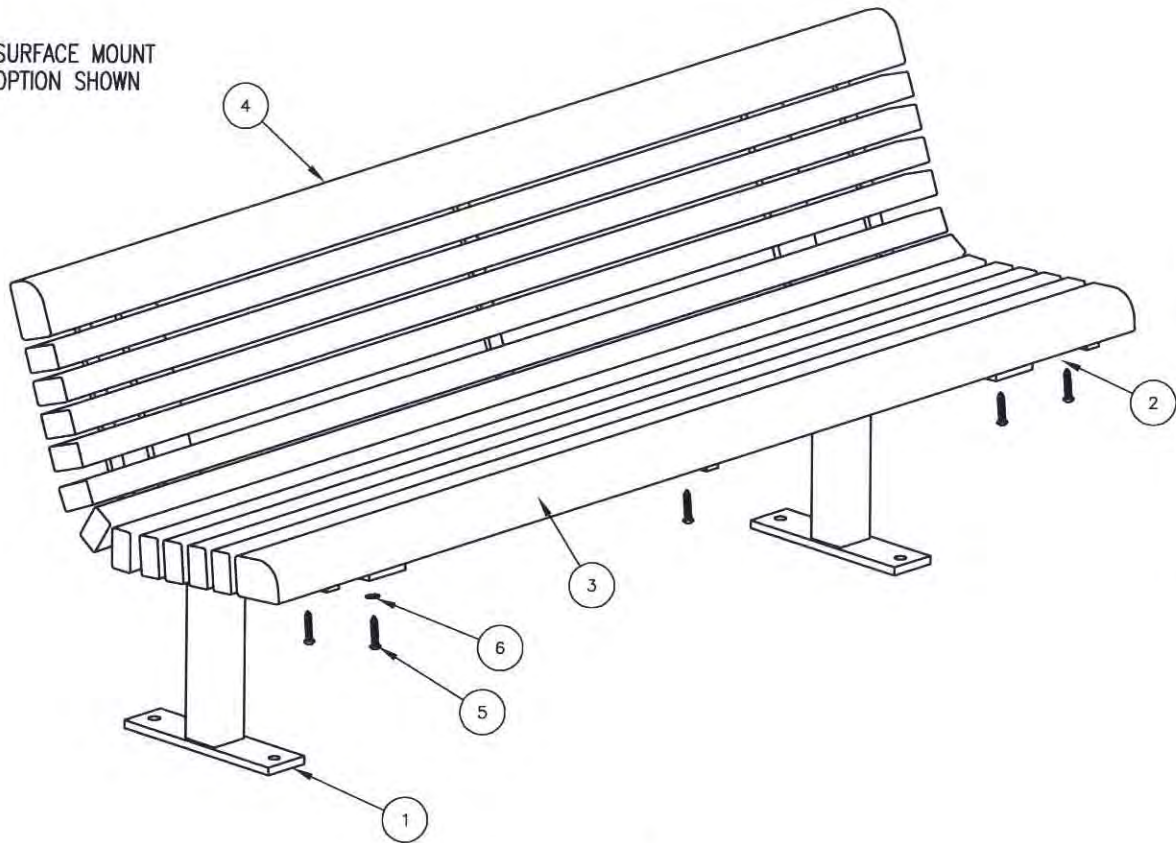

**STEP 1:**

- USE 2 - PCS. SEAT SUPPORT FOR SURFACE MOUNT ( 1 )
- 2 - PCS. 3" X 4" X 71" WOOD EDGE SLAT ( 4 )
- 11 - PCS. 2" X 3" X 71" WOOD INT'R SLAT ( 3 )
- 26 - PCS. 3/8" X 2" SS. BTN. SKT. HD. LAG SCR. ( 5 )
- 26 - PCS. 3/8" SS. FLAT WASHER ( 6 )

ATTACH SLATS ( 3 & 4 ) TO SEAT SUPPORT FOR SURFACE MOUNT ( 1 ) USING HARDWARE ( 5 & 6 ). TIGHTEN TO SNUG FIT. REPEAT UNTIL ALL SLATS ARE ATTACHED.

**STEP 2:**

- USE 3 - PCS. CONTOUR STRAP ( 2 )
- 39 - PCS. 3/8" X 2" SS. BTN. SKT. HD. LAG SCR. ( 5 )
- 39 - PCS. 3/8" SS. FLAT WASHER ( 6 )

ATTACH CONTOUR STRAP ( 2 ) TO STEP 1 ASSEMBLY USING HARDWARE ( 5 & 6 ). TIGHTEN TO SNUG FIT.

**STEP 3:**

UPON COMPLETION OF BENCH ASSEMBLY SQUARE ALL COMPONENTS THEN TIGHTEN ALL HARDWARE.

**STEP 4:**

ANCHOR ACCORDING TO SUPPORT OPTION USED.

**NOTE:**

- 1.) DURING ASSEMBLY PROCEDURE;  
DO NOT COMPLETELY TIGHTEN HARDWARE.
- 2.) THE ACTUAL PARTS WILL NOT BE NUMBERED;  
NUMBERS ONLY APPLY TO DRAWING.
- 3.) SEE SPEC. SHEET 1 FOR MOUNTING OPTION.

ITEM	QTY	PART NO	DESCRIPTION
1	2	0-39-00-03/S-2	SUPPORT FOR SURFACE MT
2	3	0-39-00-04	CONTOUR STRAP
3	11	0-39-60-01	2" X 3" X 71" WOOD SLAT
4	2	0-39-60-02	3" X 4" X 71" WOOD EDGE SLAT
5	65	1-13-016	3/8" X 2" SS BTN SKT HD LAG SCR
6	65	1-22-024	3/8" SS FLAT WASHER

**DuMor, inc.**  
P.O. Box 142 Mifflintown, PA 17059-0142

SCALE : NONE  
DATE DRAWN : 3/24/94  
DRAWN BY : AH  
DATE REV. : 10/18/99  
REV. BY : JSB

TITLE : BENCH ASSEMBLY  
REV. C  
DRAWING NUMBER 39 SERIES  
SHEET 2 OF 2

## MATERIALS SPECIFICATIONS FOR BENCH 39

### MATERIALS

Bench 39 shall be made from supports: 1/2" x 3" steel bar and 2-1/2" square x 1/4" wall steel tube, contour straps: 3/8" x 1" steel bar, slats: 2" x 3" nom. interior and 3" x 4" nom. edge slats in choice of clear of all heart, free of heart center Redwood, clear Douglas Fir and Western Red Cedar (all with clear preservative treatment), fasteners: stainless steel. See chart below for models and sizes.

### AVAILABLE MODELS

#### Description

6' Redwood Bench Model 39-60R

Weight (lb) 150

Length (ft) 6

Supports 2

8' Redwood Bench Model 39-80R

Weight (lb) 178

Length (ft) 8

Supports 2

6' Douglas Fir Bench Model 39-60D

Weight (lb) 150

Length (ft) 6

Supports 2

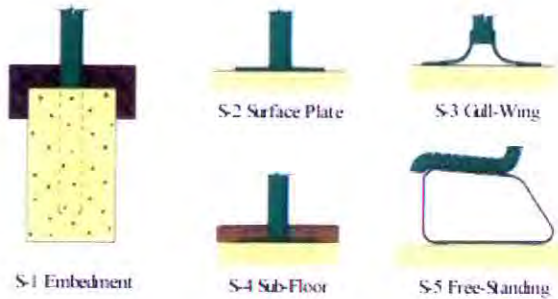

### OPTIONS

#### Support Options

1. S-1 Embedment
2. S-2 Surface Plate
3. S-3 Gull Wing
4. S-4 Sub-Floor

#### Frame Finish

Most DuMor™ products are available in your choice of several color options in a durable baked-on polyester powder finish. Additional colors are available at an extra cost. (Bronze)

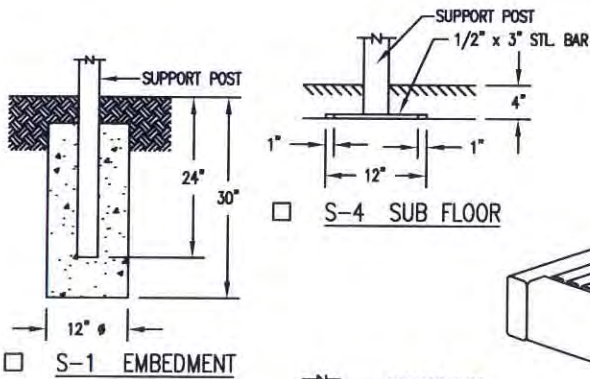
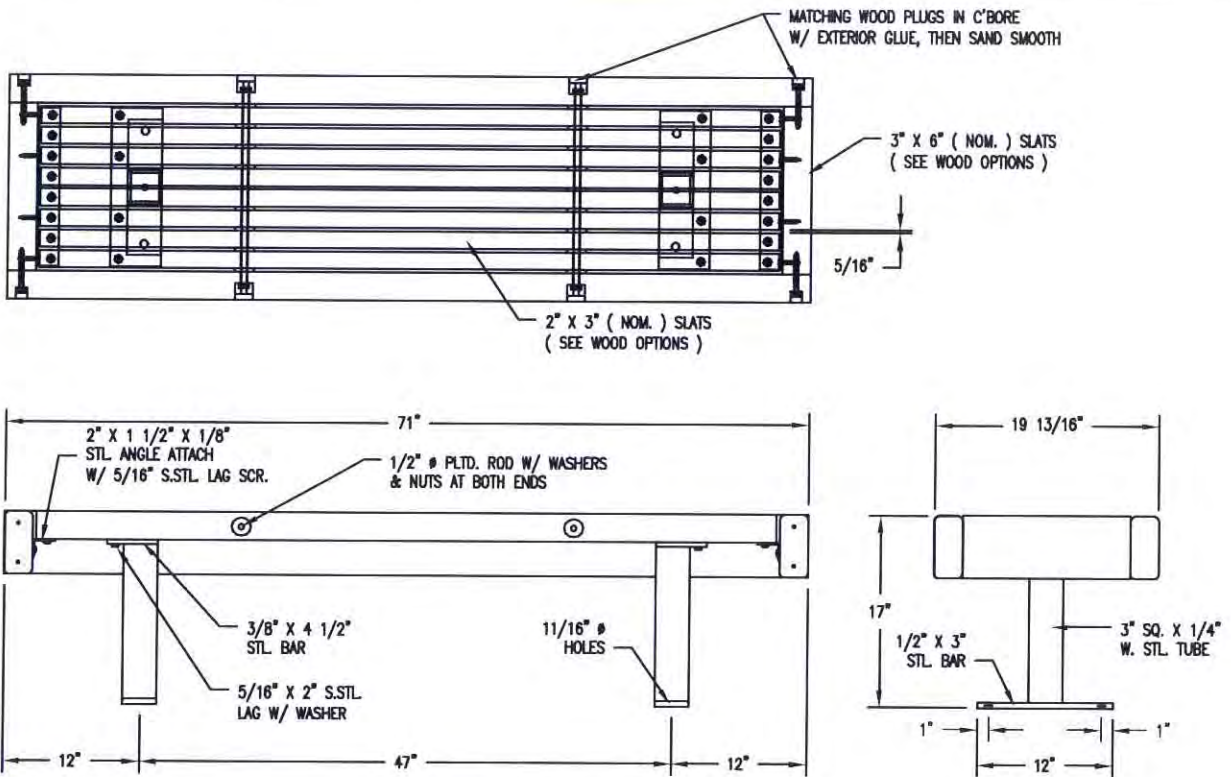

S-2 SURFACE

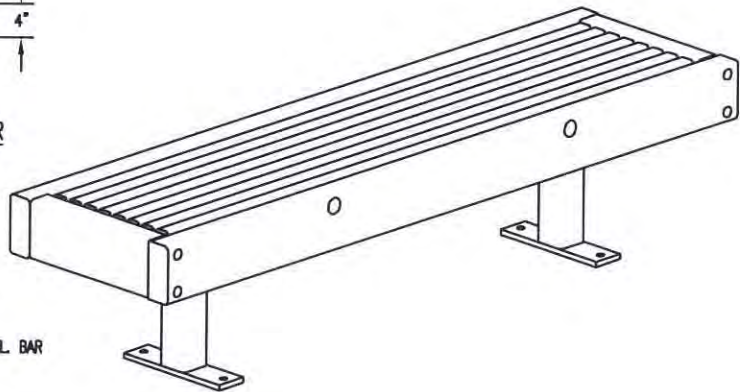

**NOTES**

- 1.) ALL STL. MEMBERS COATED W/ ZINC RICH EPOXY THEN FINISHED W/ POLYESTER POWDER COATING.
- 2.) ALL WOOD MEMBERS TREATED W/ CLEAR PRESERVATIVE.
- 3.) SEAT PORTION SHIPPED FULLY ASSEMBLED.
- 4.) 1/2" X 3 3/4" PLTD. EXPANSION ANCHOR BOLTS PROVIDED FOR S-2, S-3 & S-4 OPTIONS.

**WOOD OPTIONS**

- CLEAR ALL HEART REDWOOD S4S EE
- 'C' & BTR. DOUGLAS FIR KD S4S EE
- CLEAR WESTERN RED CEDAR S4S EE
- OTHER \_\_\_\_\_

**DuMor, inc.**  
P.O. Box 142 Mifflintown, PA 17059-0142

SCALE : NONE  
DATE DRAWN : 3/22/94  
DRAWN BY : AH  
DATE REV. : 11/14/01  
REV. BY : JSB

TITLE :

BENCH

REV. E

DRAWING NUMBER

37-60

SHEET 1 OF 2

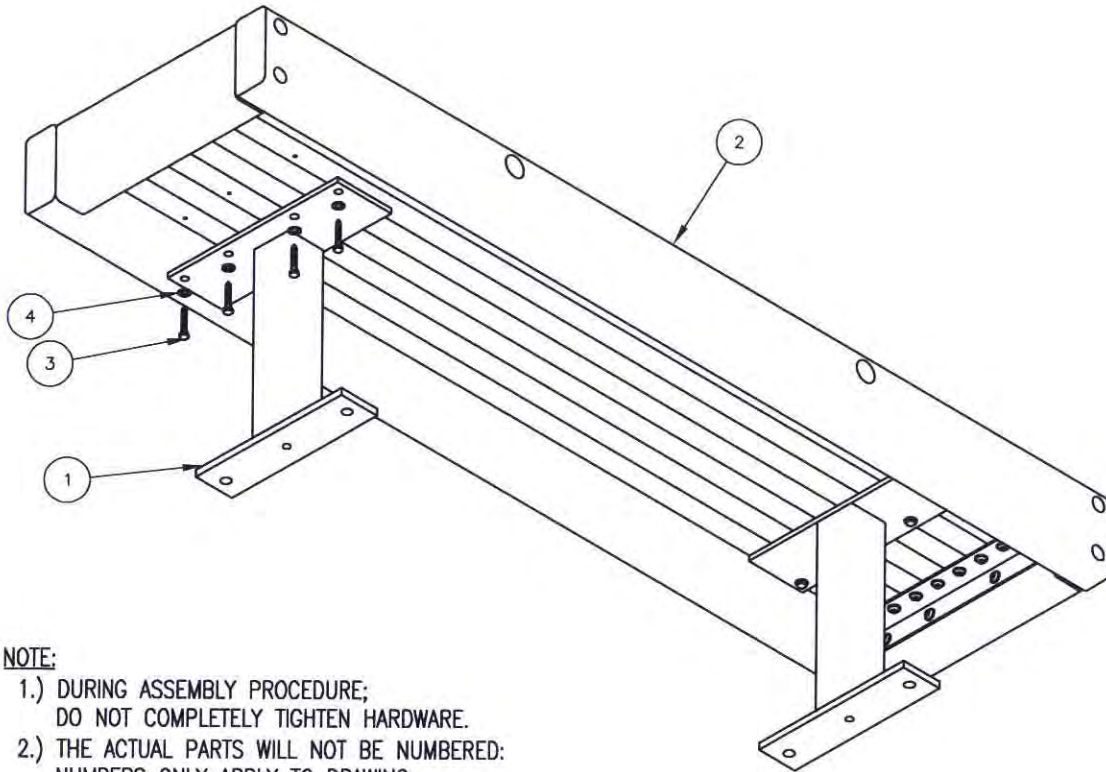

**NOTE:**

- 1.) DURING ASSEMBLY PROCEDURE;  
DO NOT COMPLETELY TIGHTEN HARDWARE.
- 2.) THE ACTUAL PARTS WILL NOT BE NUMBERED;  
NUMBERS ONLY APPLY TO DRAWING.
- 3.) SEE SPEC. SHEET 1 FOR MOUNTING OPTIONS.

**STEP 1:**

USE 2 - PC. SUPPORT FOR SURFACE MOUNT ( 1 )  
 1 - PC. SEAT ASSEMBLY ( 2 )  
 8 - PCS. 5/16" X 2" SS. HEX LAG ( 3 )  
 8 - PCS. 5/16" SS. FLAT WASHER ( 4 )  
 ATTACH SUPPORTS FOR SURFACE MOUNT ( 1 ) TO SEAT ASSEMBLY  
 ( 2 ) USING HARDWARE ( 3 & 4 ). TIGHTEN TO SNUG FIT.

**STEP 2:**

UPON COMPLETION OF BENCH ASSEMBLY SQUARE ALL  
 COMPONENTS THEN TIGHTEN ALL HARDWARE.

**STEP 3:**

ANCHOR ACCORDING TO SUPPORT OPTION USED.

ITEM	QTY	PART NO	DESCRIPTION
1	2	0-37-00-02/S-2	SUPPORT FOR SURFACE MOUNT
2	1	0-37-60-01	6" SEAT ASSEMBLY
3	8	1-13-038	5/16" X 2" SS HEX HD LAG SCR
4	8	1-22-017	5/16" SS FLAT WASHER

  
**DuMor, inc.**  
 P.O. Box 142 Mifflintown, PA 17059-0142

SCALE : NONE  
 DATE DRAWN : 3/22/94  
 DRAWN BY : AH  
 DATE REV. : 11/14/01  
 REV. BY : JSB

TITLE :		BENCH ASSEMBLY	
REV.	DRAWING NUMBER		SHEET
E	37-60		2 OF 2

## **No. 2118-6 Restoration Bench with Armrests**

Bench shall be **TimberForm® Restoration™** series model No. 2118-6 six feet long, with armrests. Manufacturer, Columbia Cascade Company, 1975 SW Fifth Avenue, Portland, OR 97201-5293 U.S.A.

### **1. Materials**

Bench frames shall be cast iron, cast in accordance with ASTM, Specification A48-82, Class 30. Stretcher pipe shall be 1-inch I.D. schedule 40 mild steel seamless pipe. Center support strap shall be 2-inch wide x .25 inch thick-formed mild steel strap. All wood shall be clear, kiln dried, **Purple Heart**, precision milled to pattern, dressed to a smooth finish with eased edges and ends, individually selected for quality and appearance.

### **2. Construction**

Bench frames shall have all parting lines and flask marks ground smooth after casting. Stretcher pipe and center support strap shall be deburred and ground smooth. Bench slats shall be attached to cast iron frames and center support strap with No. 10 x 1-1/4 inch stainless steel pan head screws.

### **3. Finish**

Steel and cast iron parts shall be coated with CASPAX-7™; a tough, opaque, UV resistant exterior grade polyester powder coating applied to a minimum thickness of 6 mils. Liquid, epoxy or lead-containing powder coatings are not acceptable. **Color shall be Dark Bronze.**

Preparation of the mild steel substrate shall incorporate the phosphate system. Substrate preparation shall consist first of mechanical cleaning to remove heavy mill scale, rust, varnish, grease, etc. with surfaces uniformly abraded to promote quality of finish coating. Chemical cleaning in accordance with TT-C-490C, Methods I and III shall remove impurities from the surfaces.

After the two-step cleaning process, the metal substrate shall receive a corrosion-inhibiting iron phosphate pre-coating in accordance with TT-C-490C, Type II, prior to the application of the powder color coat. The color coating shall be applied by the electrostatic method and then oven-cured at 400 degrees Fahrenheit to chemically bond the coating to the substrate and to render the coated metal resistant to abrasion, impact, chipping, weathering, and rusting.

Memorial Park Project:

Quantity: 6

Install 2 per sitting area as shown on plan.

Wood slats to be Purple Heart

Hardware to be Dark Bronze

Provide two anchor points Bench

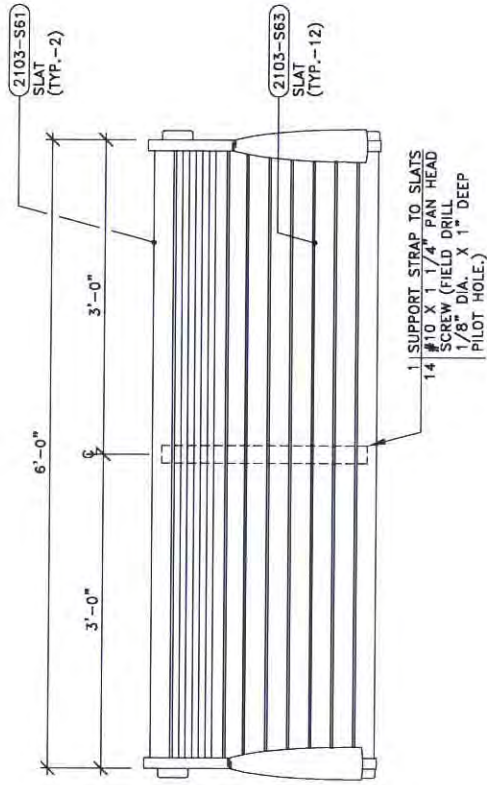

PLAN VIEW

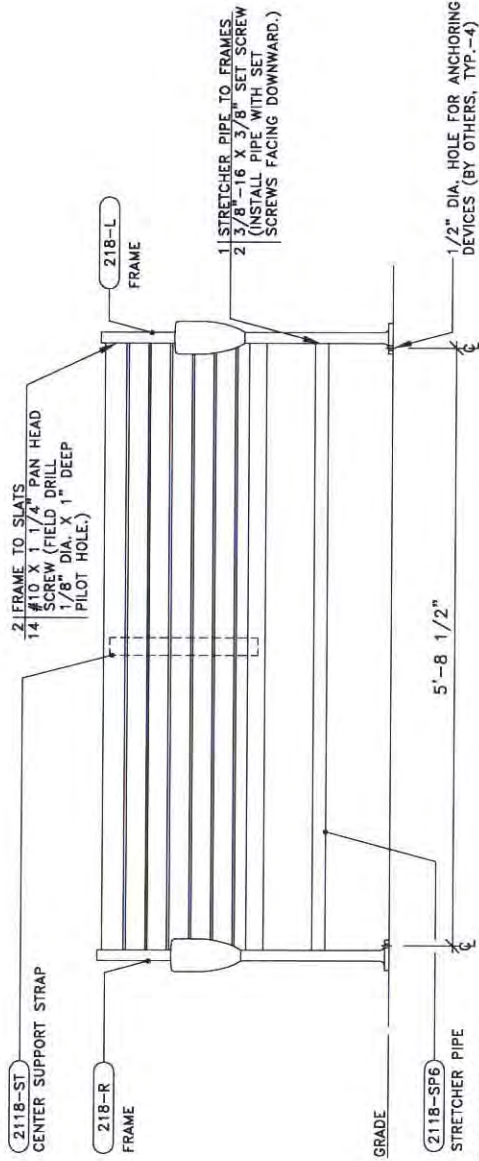

ELEVATION

ADDITIONAL INSTALLATION NOTES:

- BEFORE ANCHORING, ASSEMBLE CAST IRON FRAMES, SLATS, AND STRETCHER PIPE PER NOTES 2-5. USE ASSEMBLED BENCH TO LOCATE ANCHORS.
- INSTALL STRETCHER PIPE SO THAT THE ENDS ARE FLUSH WITH THE FRAMES.
- EACH SLAT SHOULD BE POSITIONED SO THAT THE BEST FACE IS EXPOSED WHEN ASSEMBLED. NOTE THAT THE BACKREST HAS TWO (2) VISIBLE FACES. THEREFORE, THOSE SLATS HAVING ONE BLEMISHED FACE SHOULD BE INSTALLED ON THE SEAT PORTION OF THE BENCH WITH THE BEST FACE VISIBLE.
- ATTACH SLATS TO END FRAMES AFTER DRILLING PILOT HOLES.
- AFTER SLATS ARE FASTENED TO END FRAMES, ALIGN ALL SLATS FOR UNIFORM SPACING IN CENTER AREA. WE RECOMMEND THE USE OF TEMPORARY SHIMS AS NECESSARY. ATTACH CENTER SUPPORT STRAP TO BACK OF SLATS. REMOVE SHIMS AFTER ATTACHING STRAP.

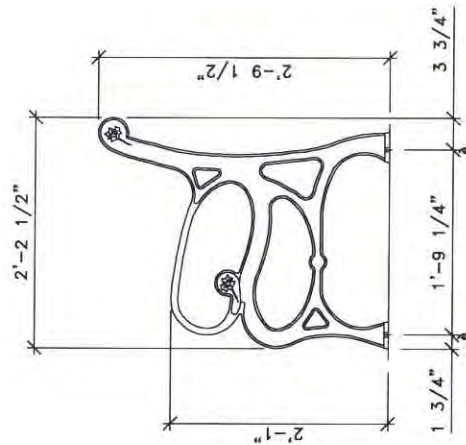

END VIEW

		THE COLUMBIA CASCADE COMPANY Division of TimberCraft TimberCraft Hardware and Pipe/Fabric Products	
1000 S.W. 77th Avenue Portland, Oregon 97223-4535 U.S.A.		Telephone 503/223-1157 Facsimile 503/223-4535	
Date	Revision	By	
10-18-99	REV. P.C. MAKE	ZZ/CL	
09-18-99	ADD NOTE	SK/MPC	
1'-1'-0"	CL	CL	09-18-99

THE TIMBERFORM RESTORATION MODEL NO. 2118-6 BENCH WITH ARMRESTS	
Drawing No.	E-2118-6
Sheet	1 of 1



# Standard Campus Bollards

2 1/4" diameter  
with black coated  
1/4" chain



4" diameter

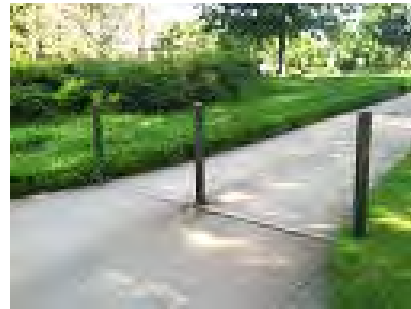

6" diameter





## Our Purpose Is To Enrich Outdoor Spaces

We believe in the power of design and its ability to influence and elevate the quality of public space. High quality products and outstanding customer experience makes us one of the world's premier designers and manufacturers of outdoor commercial furnishings.

### KaleidoscopeOS® Specifications

Kaleidoscope standard elements have been engineered to meet building codes across the U.S. Stringent load tests were performed by Landscape Forms. Based on this data, structural engineers calculated snow and wind load ratings for all standard elements. Kaleidoscope meets:

- Wind load of 146 mph, exposure C (IBC)
- Snow load of 40 lbs. per square foot @ 90 mph, exposure B

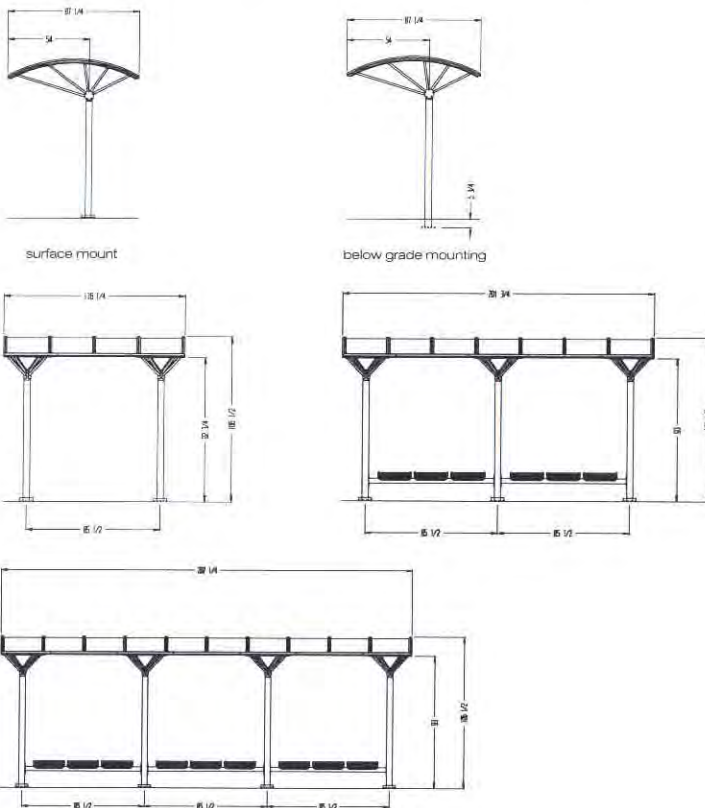

### Footings

Kaleidoscope can be ordered for surface mounting at grade with cover plates or below grade mounting. Anchor bolts with nuts are used to level canopy posts for both mounting styles. Ground and footing preparation is necessary. Kaleidoscope posts must be mounted on concrete footings. Caisson, spread, and pad style footings are all possible and custom designed for different building code conditions.



### Low Voltage Lighting

Low voltage lighting (1.2 volts) is available. Lighting package consists of light housing and transformer and may be ordered through Landscape Forms. Accepts 20 to 75 watt low voltage halogen MR16 lamp. Bulb and wiring are not included. Standard light housing is a bronze color. Additional colors available for an upcharge. Call for details. All lighting components are UL listed. Landscape Forms recommends a licensed contractor install lighting. Landscape Forms is not responsible for verifying that lighting meets local codes.

### Solar Power Lighting

Solar powered lighting is available. The unit operation is completely automatic, illuminating from dusk to dawn without interruption, increasing security and safety. Using the solar panels mounted on the roof of the shelter, the controller determines when to turn the LED lighting on or off. The Solar Powered Lighting package consists of Photovoltaic collectors, storage batteries, controller, mounting brackets, hardware, and LED Luminaire(s). The low profile canopy mounted cabinet for the battery bank and controller is powder coated to match canopy.

### Fit and Finish

Kaleidoscope is precisely engineered to look and wear beautifully in the public eye. Our exclusive, proven Pangard II® powdercoat process protects each unit with a hard yet flexible skin that resists rusting, chipping, peeling and fading. Kaleidoscope is covered by a three-year warranty.

### landscapeforms.com

Visit our website for product details, color charts, technical sheets, sales office locations. Download JPG images, brochure PDF, CAD details, CSI specifications.

Kaleidoscope® is designed by Robert Chipman, ASLA; Brian Kane, IDSA; and Arno Yurk, AIA, IDSA. Kaleidoscope design is protected by U.S. Patent Nos. D432,665; D420,612; D421,132; D429,000; D412,993; D413,314. Specifications are subject to change without notice. Kaleidoscope is manufactured in U.S.A. Landscape Forms supports the LAF at the Second Century level. ©2010 Landscape Forms, Inc. Printed in U.S.A.



Metal is the world's most recycled material and is fully recyclable. Consult our website for recycled content for this product. Powdercoat finish on metal parts contains no heavy metals, is IAPPS-free and has extremely low VOCs.



Landscape Forms is proud to specify FSC and Green-e certified paper. This paper meets the Forest Stewardship Council's standards for responsible forest management and is made using certified renewable energy.

800.521.2546 269.381.3455 fax  
431 Lawndale Avenue, Kalamazoo, MI 49048  
landscapeforms.com

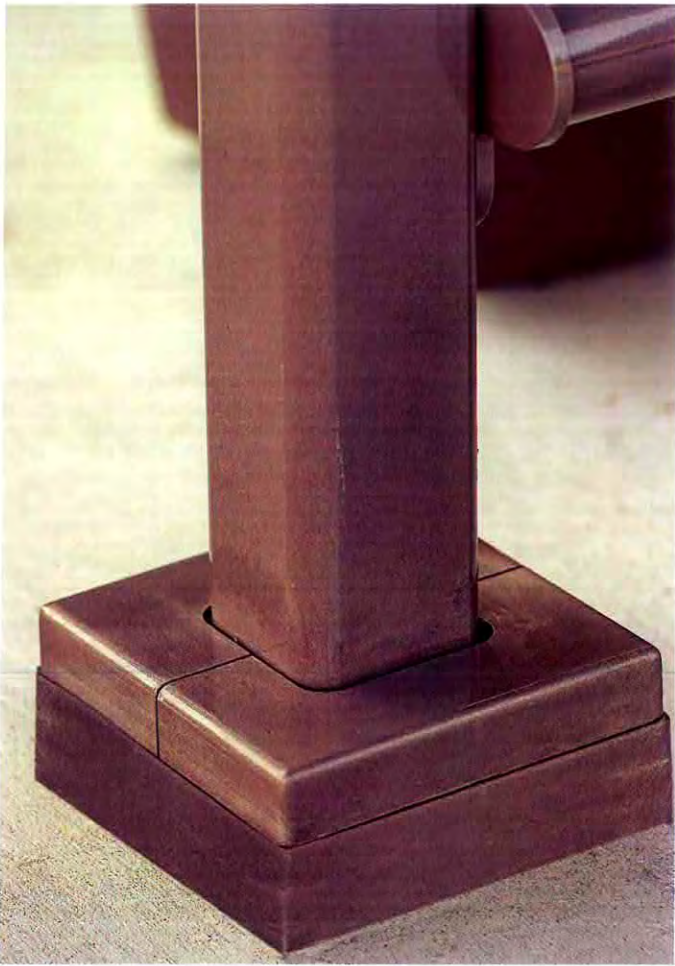

# powdercoat

Standard colors are shown below. Colors are approximate. A wide selection of optional colors may be specified for an upcharge. To make final color selections, please call for a color chart.



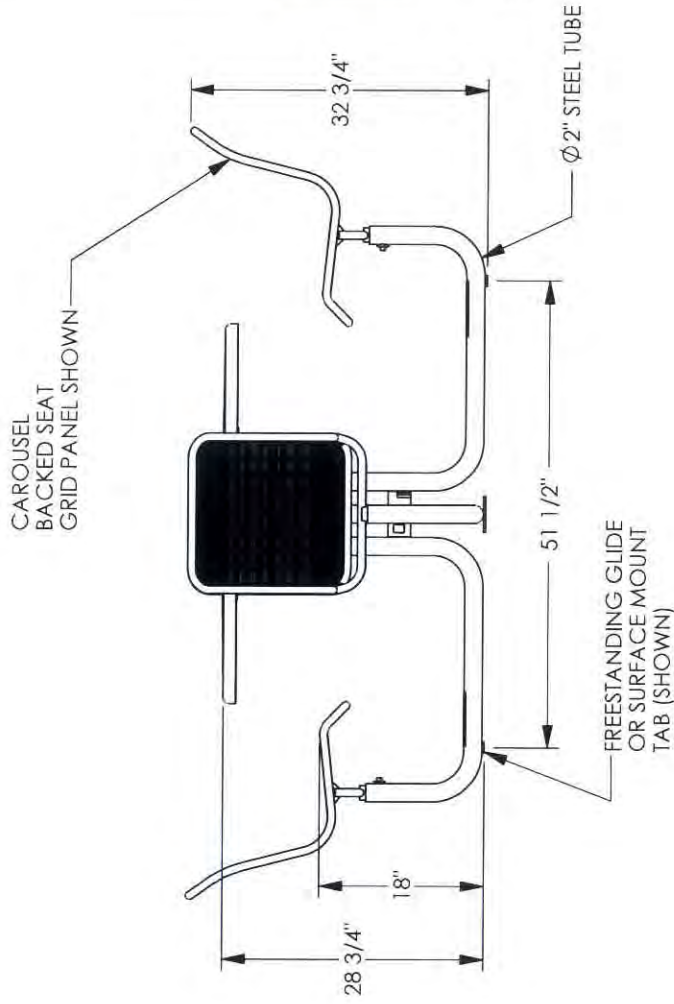
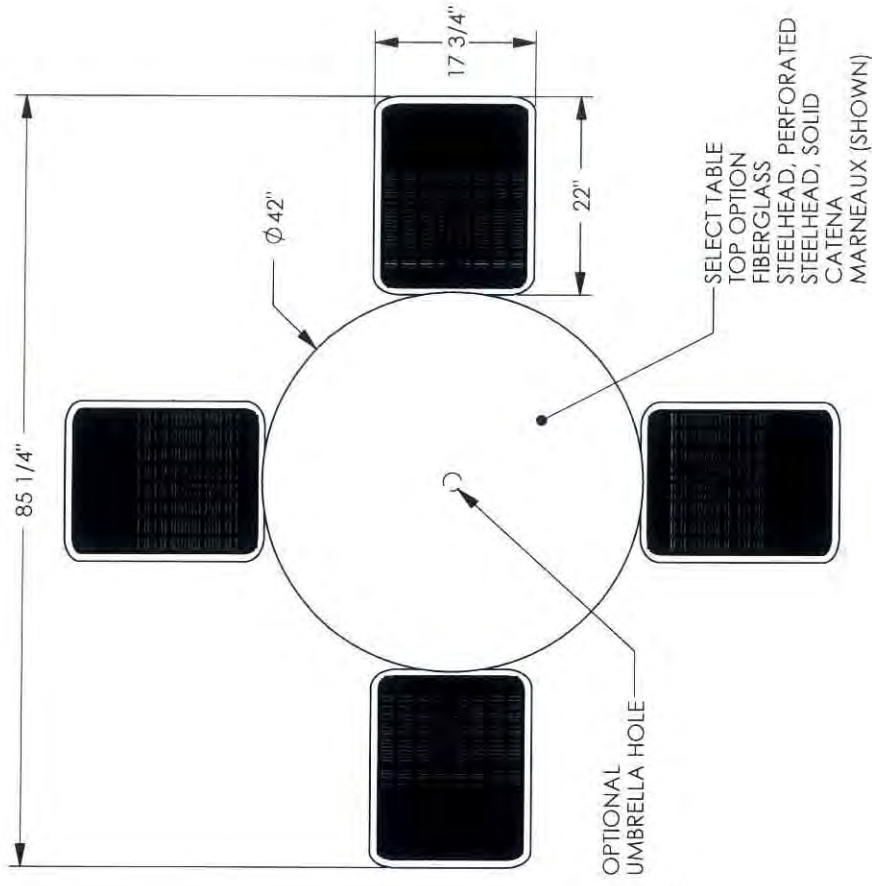

# l a n d s c a p e f o r m s ®

431 LA WINDALE AVE.  
KALAMAZOO, MI 49048  
PHONE: 800-521-2546  
FAX: 269-381-3455

CONFIDENTIAL DRAWING INFORMATION CONTAINED HEREIN IS THE PROPERTY OF LANDSCAPE FORMS, INC. INTENDED USE IS LIMITED TO DESIGN PROFESSIONALS SPECIFYING LANDSCAPE FORMS, INC. PRODUCTS AND THEIR DIRECT CLIENTS. DRAWING IS NOT TO BE COPIED OR DISCLOSED TO OTHERS WITHOUT THE CONSENT OF LANDSCAPE FORMS, INC.

© 2005 LANDSCAPE FORMS, INC. ALL RIGHTS RESERVED.

DESIGN GROUP: CAROUSEL  
DESCRIPTION: 4 SEAT SURFACE MOUNT UNIT WITH BACKED GRID SEATS  
PATENT: CR124-02  
FILE: CR124-02  
DATE: 9/26/2005  
DRAWN BY: TAH

## Seats and Supports

Carousel tables are available with 3, 4, 5 or 6 seats. Three-seat is ADA compliant and five-seat styles are wheelchair accessible. Seats are available in backed or backless styles. Supports are formed of 2" steel tubing. Umbrella holder is a built in feature on all supports.



Outside dimensions across table to back of seats is approximately 82" for backless and 85" for backed seats

## Tabletop

42" in diameter and 29" high. Steelhead and Catena tabletops are formed of heavy gauge steel reinforced with channels beneath.

Catena features a rolled edge; Steelhead is framed by a 1-1/2" diameter metal tube and may be specified with solid or perforated top.

Mameaux tabletops are made from a 100% acrylic resin solid surface material. Its been a designer-preferred material for countertops because it resists scratching, staining, chipping and cracking. Weather, harsh chemicals, and UV rays have virtually no effect on the "throughbody" color or structural integrity.

All tabletops are available with or without umbrella holes, Umbrella hole must be specified when ordered; cannot be retrofitted on site.



## Finishes

All metal is finished with Landscape Forms' proprietary Pangard II® polyester powdercoat, a hard yet flexible finish that resists rusting, chipping, peeling, and fading. Call for standard color chart.



Metal is the world's most recycled material and is fully recyclable. Powdercoat finish on metal parts contains no heavy metals, is HAPS-free and has extremely low VOCs. Consult our website for recycled content for this product.



Landscape Forms is proud to specify FSC and Green-e certified paper. This paper meets the Forest Stewardship Council's standards for responsible forest management and is made using certified renewable energy.

## Seat Panels

Select metal grid or perforated metal.



grid



perforated metal

## Mounting Options

**Three-seat style must be surface mounted.** Four, five and six seat styles may be freestanding with glides or surface mounted. All tables must be surface mounted when used with Solstice or Shade umbrellas.



freestanding with glides



surface mount

## To Specify

1. Select Carousel table with backed or backless seats.
2. Select 3, 4, 5 or 6 seats; metal grid or perforated metal
3. Select tabletop: Steelhead (solid or perforated), Catena powdercoat or stainless steel, or Mameaux.
4. Specify with or without umbrella hole (may not be retrofitted).
5. Choose powdercoat color for metal parts or Mameaux color if applicable.
6. Specify freestanding with glides, or surface mount.

## www.landscapeforms.com

Download product photos, brochures, color charts, SketchUp components, technical information, CAD details, CSI specifications, assembly instructions.

Carousel is designed by Arno Yurk AIA, IDSA. Specifications are subject to change without notice. Carousel is manufactured in U.S.A.

Location photography: Millenium Park, Chicago & Brook Lodge, Augusta, MI. Landscape Forms supports the LAF at the Second Century level. © 2011 Landscape Forms, Inc. Printed in U.S.A.

## landscapeforms®

800.521.2546 269.381.3455 fax  
431 Lawndale Avenue, Kalamazoo, MI 49048  
www.landscapeforms.com

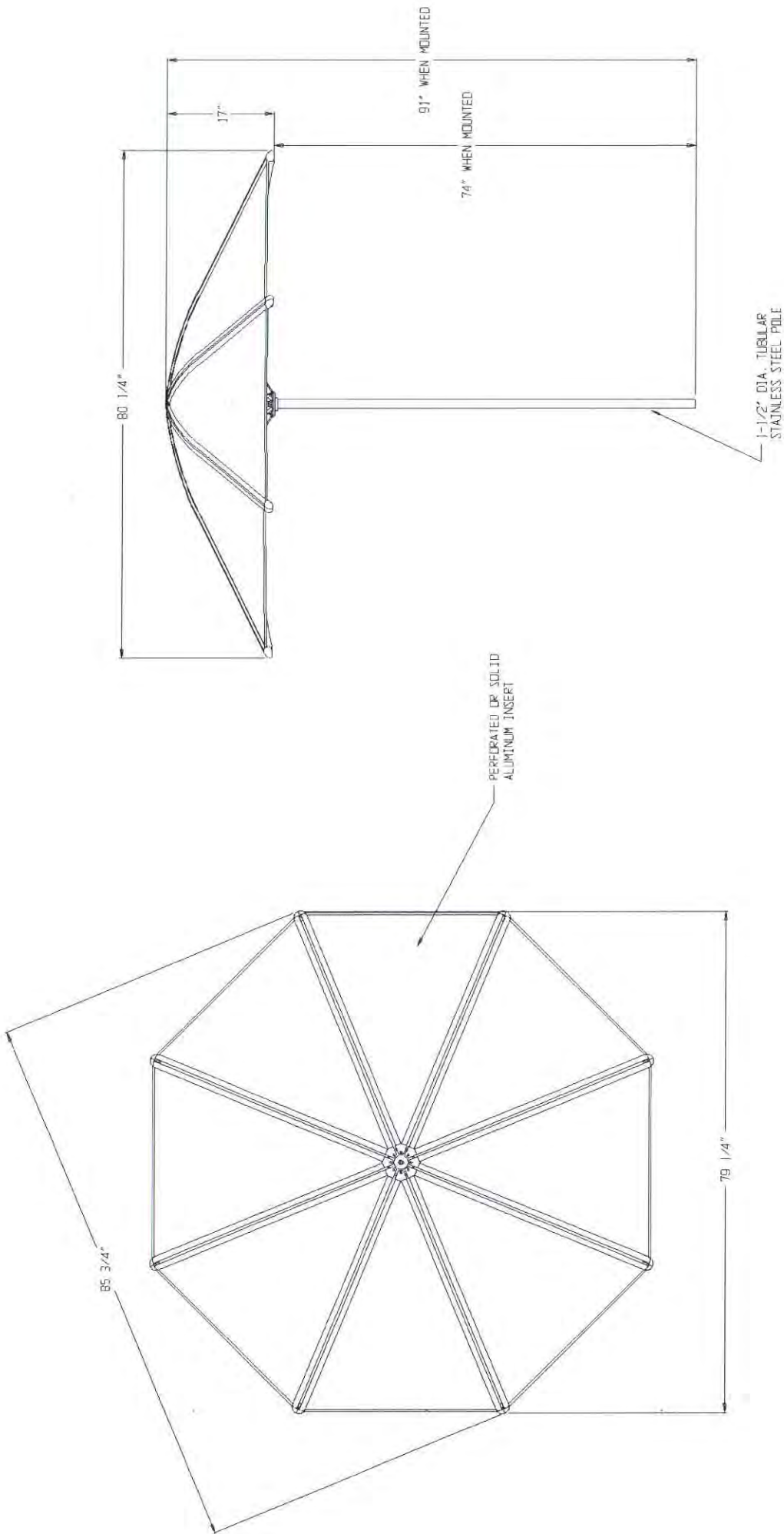

TITLE: 66" DIA. X 91" H - SOLSTICE ALTAIR SUN SHADE  
 DESIGN: SOLSTICE  
 PATENT: D-973,467  
 FILE: AL207-01  
 DATE: 07-05-05  
 AUTHOR: LAO

l a n d s c a p e f o r m s  
 431 LAWDALE AVE. PHONE: 800-527-2546  
 KALAMAZOO, MI 49008 FAX: 269-381-2455  
 CONFIDENTIAL DRAWING INFORMATION CONTAINED HEREIN IS THE PROPERTY OF LANDSCAPE FORMS, INC. INTENDED USE IS LIMITED TO DESIGN PROFESSIONALS SPECIFYING LANDSCAPE FORMS, INC. PRODUCTS AND THEIR DIRECT CLIENTS. DRAWING IS NOT TO BE COPIED OR DISCLOSED TO OTHERS WITHOUT THE CONSENT OF LANDSCAPE FORMS, INC.  
 © 1995 LANDSCAPE FORMS, INC. ALL RIGHTS RESERVED.

## Our Purpose Is To Enrich Outdoor Spaces

We believe in the power of design and its ability to influence and elevate the quality of public space. High quality products and outstanding customer experience makes us one of the world's premier designers and manufacturers of outdoor commercial furnishings.

### Solstice Specifications

Solstice™ shade panels are solid or perforated aluminum, mounted in an extruded aluminum frame. Struts are extruded aluminum. Top cap, strut ring and end caps are aluminum castings. Single-piece pole, fasteners and hardware are stainless steel. Surface mount stand is steel.

### Solstice Collection Styles

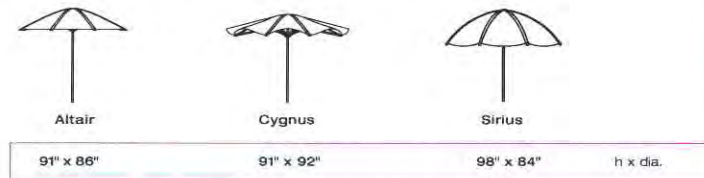

### Panel Mount

Aluminum panels are mounted in notched, extruded aluminum frame pieces. End caps are aluminum castings.



### Surface Mount

Stand includes two stainless steel bolts to hold the Solstice pole in place and must be used when Solstice sun shade is not mounted to a Landscape Forms table. Anchoring hardware not included.



### Metal Finishes

All metal parts are finished with Landscape Forms' exclusive Pangard II® polyester powdercoat – a hard, yet flexible, finishing process that resists rusting, chipping, peeling and fading.

### Mounting

When used with a Landscape Forms table, Solstice must be mounted to the table, which in turn must be mounted to, or embedded in, a hard surface. If used with a table other than those offered by Landscape Forms, Solstice must be anchored to our surface-mounted stand. Solstice may also be used without a table, but must be secured in our surface-mounted stand.

### To Specify:

Specify Altair, Cygnus or Sirius sun shade. Select perforated or solid panels, and powdercoat color(s). Specify to mount in Landscape Forms surface mount or embedded table. Specify surface mount stand if using with table other than those supplied by Landscape Forms, or if used without a table. Specify color for stand.

[www.landscapeforms.com](http://www.landscapeforms.com)

Visit our website for product details, color charts, technical sheets, and sales office locations. Download JPG images, brochure PDF, CAD details, and CSI specifications.

Solstice is designed by Robert Chipman, ASLA.  
Specifications are subject to change without notice.  
Solstice collection is manufactured in U.S.A.  
Solstice design is protected by U.S. Patent Nos. D373,467; D373,465; D373,466.  
Landscape Forms supports the LAF at the Second Century level.  
© 2004 Landscape Forms, Inc. Printed in U.S.A.



Metal is the world's most recycled material and is fully recyclable. Powdercoat finish on metal parts contains no heavy metals, is HAPS-free and has extremely low VOCs. Contact us for more information regarding the recycled content of this product.

landscapeforms®

800.521.2546 269.381.3455 fax

431 Lawndale Ave., Kalamazoo, MI 49048

[www.landscapeforms.com](http://www.landscapeforms.com)

# Handrail at Stairs

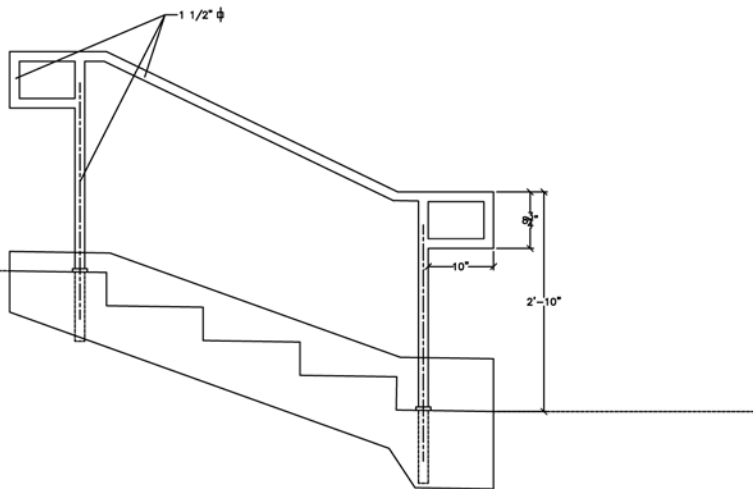

**NOTE:**

1. FIELD VERIFY ALL MEASUREMENTS  $\phi$  1 1/2" PRIOR TO FABRICATION.

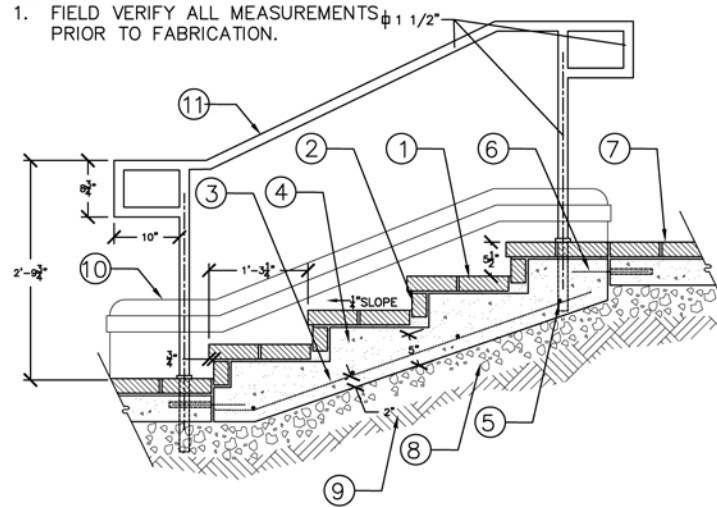

- ① DOUBLE STACKED BOND BRICK TREAD W/ JOINTS
- ② ROWLOCK STRETCHER BRICK RISER
- ③ CONCRETE BASE
- ④ #4 REBAR 6" FROM EACH SIDE OF STEP - MAX. 24" O.C.
- ⑤ #4 REBAR @ 16" O.C.
- ⑥ #4 REBAR DOWEL 12" LONG @ 24" O.C., GREASE ONE END.
- ⑦ BRICK PAVING W/ JOINTS
- ⑧ #57 CRUSHER RUN BASE
- ⑨ 98% STD. PROCTOR COMPACTED SUBGRADE
- ⑩ CHEEK WALL BEYOND
- ⑪ STEEL HANDRAIL PRIMED & PAINTED DK. DURANODIC BRONZE MAP 313



## Handrail specs.

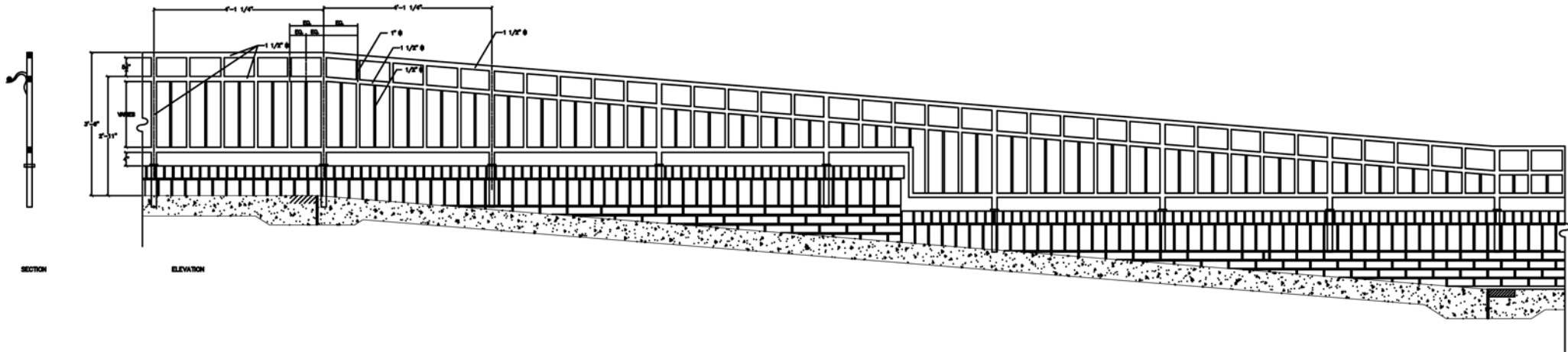

### NOTES:

HANDRAILS: FABRICATED FROM STEEL TUBING OR BAR STOCK. ALL WELDS ON HANDRAIL ARE TO BE GROUND SMOOTH; USE BONDO WHERE REQUIRED FOR SMOOTH FINISH; REMOVE ALL RUST. STRENGTH OF HANDRAIL TO CONFORM TO ADA GUIDELINES.

ALL EXPOSED SURFACES OF HANDRAIL TO BE PRIMED WITH SHERWIN WILLIAMS KEM-KROMIK METAL PRIMER (BROWN-B50N2) AND PAINTED WITH TWO COATS OF SHERWIN WILLIAMS PROMAR BRONZETONE EXTERIOR ENAMEL (CHESTNUT BRONZE).

CORE DRILL THROUGH BRICK AND CONCRETE; SET HANDRAIL WITH EPOXY. 3" SQUARE STEEL ESCUTCHEON PLATE WITH 1-1/2" SQUARE OPENING TO COVER CORE DRILLED HOLE; SPOT WELD IN PLACE FLUSH WITH PAVING SURFACE.

## NOTES:

HANDRAILS: FABRICATED FROM STEEL TUBING OR BAR STOCK. ALL WELDS ON HANDRAIL ARE TO BE GROUND SMOOTH; USE BONDO WHERE REQUIRED FOR SMOOTH FINISH; REMOVE ALL RUST. STRENGTH OF HANDRAIL TO CONFORM TO ADA GUIDELINES.

ALL EXPOSED SURFACES OF HANDRAIL TO BE PRIMED WITH SHERWIN WILLIAMS KEM-KROMIK METAL PRIMER (BROWN-B50N2) AND PAINTED WITH TWO COATS OF SHERWIN WILLIAMS PROMAR BRONZETONE EXTERIOR ENAMEL (CHESTNUT BRONZE).

CORE DRILL THROUGH BRICK AND CONCRETE; SET HANDRAIL WITH EPOXY. 3" SQUARE STEEL ESCUTCHEON PLATE WITH 1-1/2" SQUARE OPENING TO COVER CORE DRILLED HOLE; SPOT WELD IN PLACE FLUSH WITH PAVING SURFACE.



**VICTOR STANLEY, INC.**  
*-Manufacturers of Quality Site Furnishings since 1962-*

P.O. DRAWER 330 - DUNKIRK, MD 20754 USA  
 TOLL FREE: (800) 368-2573 (USA & CANADA)  
 TEL (301) 855-8300 - FAX (410) 257-7579  
 WEB SITE: HTTP://WWW.VICTORSTANLEY.COM

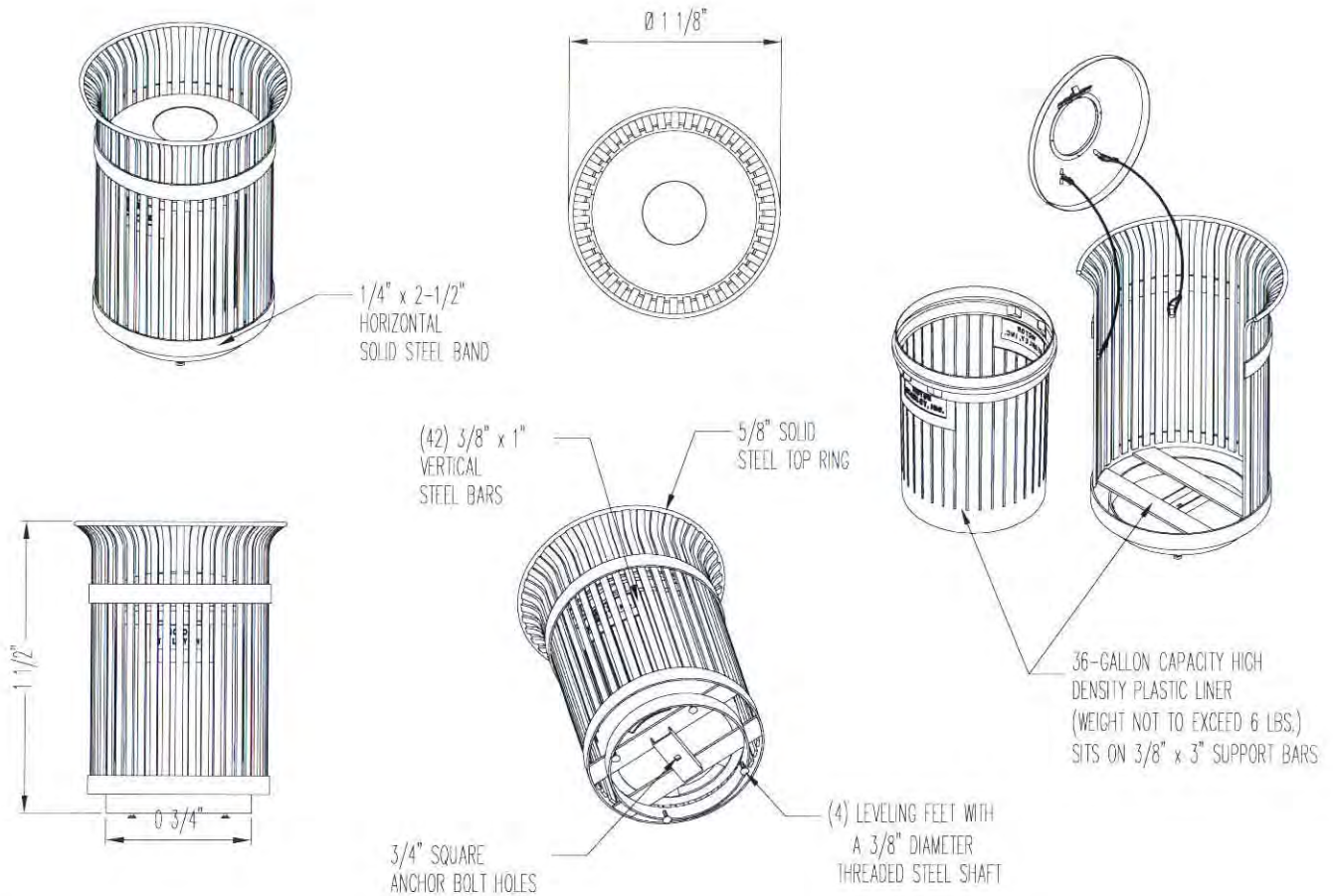

**AVAILABLE OPTIONS:**

**POWDER COATING**

10 STANDARD COLORS, CUSTOM COLORS (INCLUDING THE RAL RANGE).

**CUSTOM PLAQUES & DECALS**

AVAILABLE WITH STEEL PLAQUES IN VARIOUS SIZES AND PRESSURE SENSITIVE VINYL OUTDOOR DECALS.

**LIDS**

STANDARD TAPERED FORMED LID. AVAILABLE WITH OPTIONAL S-2 FORMED DOME, S-2 FORMED DOME WITH STAINLESS STEEL ASHTRAY, AND DS-32 FORMED DOME WITH SELF-CLOSING DOOR (AS SHOWN).

**SECURITY**

LID IS SECURED WITH VINYL COATED GALVANIZED STEEL AIRCRAFT CABLE. CABLE IS LOOPED AROUND WELDED IN PLACE ATTACHMENT BRACKETS AND CRIMPED IN PLACE. AVAILABLE WITH OPTIONAL MOUNT WITH 3 IN-LINE ANCHOR HOLES AND OPTIONAL BOTTOM PLATE COVER.

**NOTES:**

1. DRAWINGS NOT TO SCALE. DO NOT SCALE DRAWINGS.
  2. ALL FABRICATED METAL COMPONENTS ARE STEEL SHOTBLASTED, ETCHED, PHOSPHATIZED, PREHEATED, AND ELECTROSTATICALLY POWDER-COATED WITH T.G.I.C. POLYESTER POWDER COATINGS. PRODUCTS ARE FULLY CLEANED AND PRETREATED, PREHEATED AND COATED WHILE HOT TO FILL CREVICES AND BUILD FILM COATING, COATED PARTS ARE THEN FULLY CURED TO COATING MANUFACTURER'S SPECIFICATIONS. THE THICKNESS OF THE RESULTING FINISH AVERAGES 8-10 MILS (200-250 MICRONS).
  3. THIS VICTOR STANLEY, INC. PRODUCT MUST BE PERMANENTLY AFFIXED TO THE GROUND. CONSULT YOUR LOCAL CODES FOR REGULATIONS.
  4. VICTOR STANLEY, INC., PLASTIC INNER LINERS ARE MOLDED ON TOOLING DESIGNED FOR AND OWNED BY VICTOR STANLEY, INC. THEY OFFER MAXIMUM CAPACITY AND STRENGTH WITH LIGHTWEIGHT CONSTRUCTION USING CRITICAL MOLDED RIBS, INTEGRAL HANDHOLDS, AND HIGH-STRENGTH MATERIALS. THIS MINIMIZES HANDLING DIFFICULTY AND FACILITATES EASY EMPTYING AND STORAGE WHILE AFFORDING LONG SERVICE LIFE.
  5. ANCHOR BOLT NOT PROVIDED BY VICTOR STANLEY, INC.
  6. FOR HIGH SALT ABUSIVE CLIMATES, HOT DIP GALVANIZING BEFORE POWDER COATING IS AVAILABLE. SEE WRITTEN SPECIFICATIONS FOR DETAILS.
  7. ALL SPECIFICATIONS ARE SUBJECT TO CHANGE. CONTACT MANUFACTURER FOR DETAILS.
- THIS PRODUCT IS SHIPPED FULLY ASSEMBLED.

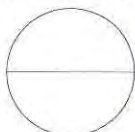

**S-42**

**IRONSITES SERIES**

36-GALLON LITTER RECEPTACLE

SHOWN: OPTIONAL DS-32 FORMED DOME LID WITH SELF-CLOSING DOOR



Ironsites® Series :: S-42 ::

Model S-42: (U.S. Patent D304,253) We are proud to be the originators of the S-42 litter receptacle. It is a world-class favorite and its design and popularity inspired us to create the complete family of Ironsites® Series products. It is shown here with standard tapered spun-steel lid.

Ironsites® Product Capacities:

S-35: 24-gallon (90 liters)  
S-42: 36-gallon (136 liters)  
S-424: 36-gallon (136 liters)  
S-45: 45-gallon (170 liters)  
SD-35: (side-door opening) 24-gallon (90 liters)  
SD-42: (side-door opening) 36-gallon (136 liters)  
PS-535: (center-post mount) 24-gallon (90 liters)  
S-20: Ash Urn  
S-24: Planter  
S-6: Tree Guard

Lid Options:

Ironsites® litter receptacles are shipped with standard spun-steel lids. Please specify lid type when order is placed.

Standard Tapered Spun-Steel Lid Optional S-1 (24-gallon) Steel Dome Lid Optional S-2 (36-gallon) Steel Dome Lid

Optional DS-24 (24-gallon) Low Profile Steel Dome with Self-Closing Door Optional 10-in diameter Stainless Steel Ashtray (for S-1 and S-2 Steel Domes) Optional DS-32 (36-gallon) Low Profile Steel Dome with Self-Closing Door

**Standard:**

All fabricated metal components are steel shotblasted, etched, phosphatized, preheated and electrostatically powder-coated with TGIC polyester powder coatings. Other standard features include a spun-steel lid attached to the frame with two vinyl-coated steel aircraft cables, a high-density plastic liner, and rubber-tipped leveling feet on the base. Interior plastic liners for all of our litter receptacles offer substantial value and are produced on molds that we designed and own. These plastic cans are reinforced, ribbed, and molded for durability, ease of use, and greater capacity. Sizes include 24-gallon (90 liters), 36-gallon (136 liters), and 45-gallon (170 liters) capacities.

## AT23 Luminaires



AT23 A

## SPECIFICATIONS

### DESCRIPTION

The acorn styled luminaire shall consist of a decorative luminaire base with an integral globe holder/ballast housing and an acorn shaped globe.

### DIMENSIONS

Fixture dimensions shall be as detailed on back page.

### MATERIALS

The luminaire base, ballast housing and globe holder shall be heavy wall, copper free, cast aluminum produced from certified ASTM 356.1 ingot per ASTM B-179-95A or ASTM B26-95, formed true to the pattern with complete detail. Globe material shall be clear textured acrylic (standard) with clear textured polycarbonate or white textured polycarbonate as options. Internal refractors shall be borosilicate glass and reflectors shall be polished aluminum. Optional finial shall be cast aluminum, and decorative banding is brass. All hardware shall be stainless steel. All exterior hardware shall be tamper resistant.

### INSTALLATION

The luminaire shall mount on a 3" O.D. x 3" tenon with six 1/4" dia. socket set screws. (Luminaires with a B Series luminaire base shall mount on a 8.25" O.D. ring.) The globe shall be secured to the luminaire by four 1/4" dia. socket set screws. The ballast and socket assembly shall be furnished with a quick disconnect plug and mount on a removable ballast plate. The ballast plate shall be removed by loosening a thumb screw.

### FINISH

For finish specifications and color options see "Finish" section in catalog.

### LIGHT SOURCE

Luminaires shall be furnished with an H.I.D. ballast and socket assembly. Luminaire shall be UL listed and labeled as suitable for wet locations. Sockets shall be glazed porcelain, mogul or medium base, with a copper alloy nickel plated screw shell and center contact. Ballast shall be core and coil, high power factor, regulating type.

### CERTIFICATION

Upon request, manufacturer shall certify the use of 356.1 ingot alloy. Upon request, manufacturer shall supply UL file# and listing information.

## ANTIQUE Street Lamps

2011-B W. Rundberg Ln. • Austin, TX 78758  
Ph (512) 977-8444 • Fax (512) 977-9622

# AT23 Luminaires

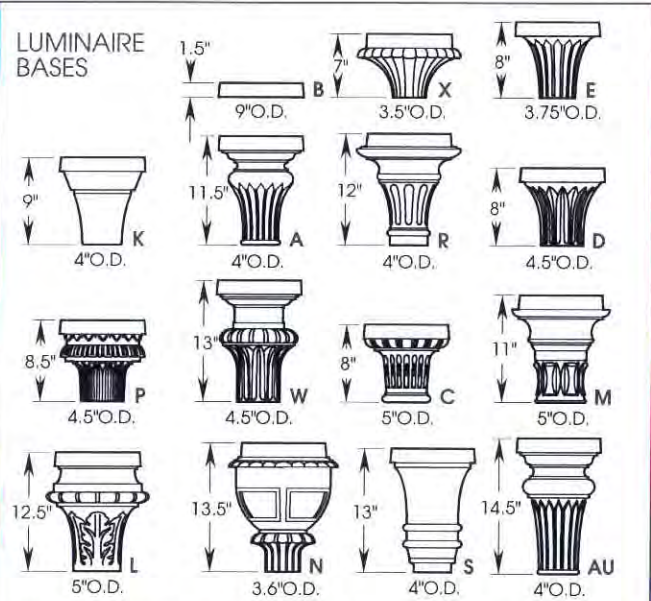
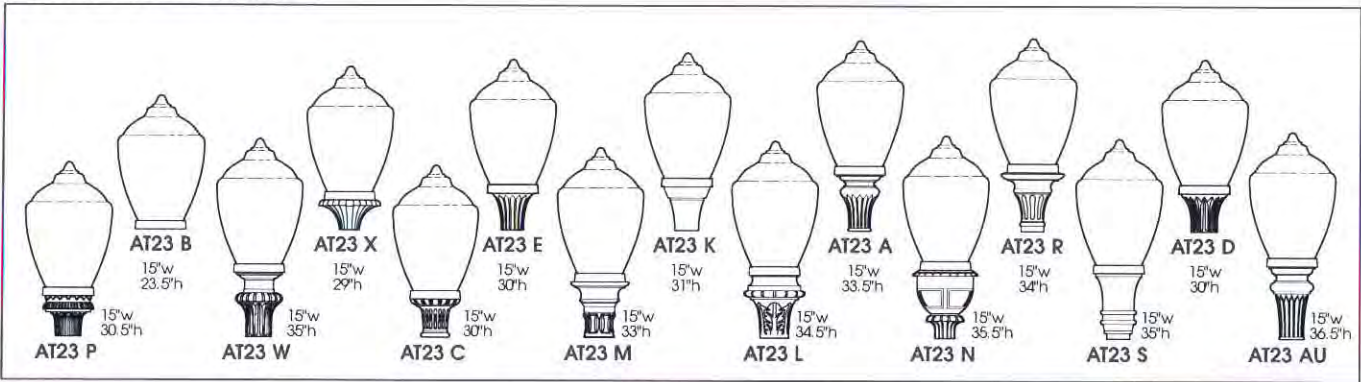

Note: Ballast housing not shown. 3" O.D. x 3" tenon required for mounting.

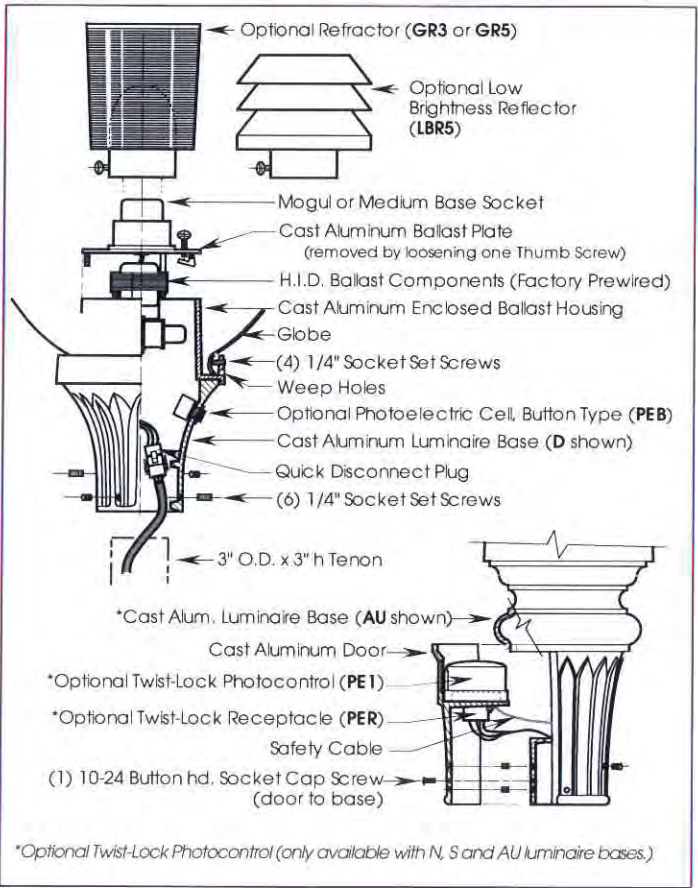

## ORDERING INFORMATION

Choose the **boldface** catalog nomenclature that best suits your needs and write it on the appropriate line.

Example: **AT23 A 75H MED ACT GR5 120 ANBK PEB1**

Series	Wattage/Lamp	Distribution	Voltage	Finish <sup>2</sup>	Options
<i>H.I.D. ballast &amp; socket</i>					
AT23 A	50H MED	(blank) Type V	120	ANBK Black	FPF Finial
AT23 AU	75H MED	GR5 Glass Refractor, Type V	208	ANDB Dark Bronze	FAB Finial and Band
AT23 B <sup>1</sup>	100H MOG	GR3 Glass Refractor, Type III	240	ANDG Dark Green	HS House Side Shield
AT23 C	175H MOG	LBR5 Low Bright. Refl., Type V	277	ANVG Verde Green	PEB1 Photoelectric Cell button 120v
AT23 D	250H MOG		347	ANPP Prime Painted	PEB2 Photoelectric Cell button 208,240,277v
AT23 E	50M MED		480	CM Custom Match	PER <sup>3</sup> NEMA Twist-Lock Receptacle only
AT23 K	70M MED		TB <sup>1</sup>	CS Custom Select RAL colors	PE1 <sup>3</sup> NEMA Twist-Lock Photocontrol 120,208,240V
AT23 L	100M MED	ACT Acrylic, Clear Textured (Standard)			PE3 <sup>3</sup> NEMA Twist-Lock Photocontrol 347V
AT23 M	150M MED	PCT Polycarbonate, Clear Textured			PE4 <sup>3</sup> NEMA Twist-Lock Photocontrol 480V
AT23 N	175M MOG	PWT Polycarbonate, White Textured			PE7 <sup>3</sup> NEMA Twist-Lock Photocontrol 277V
AT23 P	250M <sup>5</sup> MOG				SF Single Fusing
AT23 R	35S MED				DF Double Fusing
AT23 S	50S MED				
AT23 W	70S MED				
AT23 X	100S MOG				
	150S MOG				
	250S <sup>5</sup> MOG				
	42TRT				

**NOTES:**  
 1. Multi-tap Ballast (120,208,240,277v) and 480v. For wattages under 70S, 70M or 100H contact ASL for availability.  
 2. For finish and color options, see Finish section in catalog.  
 3. Twist-Lock Photo Control only available with N, S, and AU bases.  
 4. Consult factory for wattages for B Series Luminaire Base.  
 5. 250M & 250S not available with luminaire bases X, E, K, D, P and C.

**ANTIQUE Street Lamps**

2011 B.W. Rundberg Ln • Austin, TX 78758 • Ph (512) 977-8644



LUMINAIRE:  
AAT23/PP-S150/120-PEC

POST:  
A11/17-C1/PP-WPRB

ANTIQUE STREET LAMPS  
AUSTIN SERIES  
SINGLE LUMINAIRE POST LAMPS

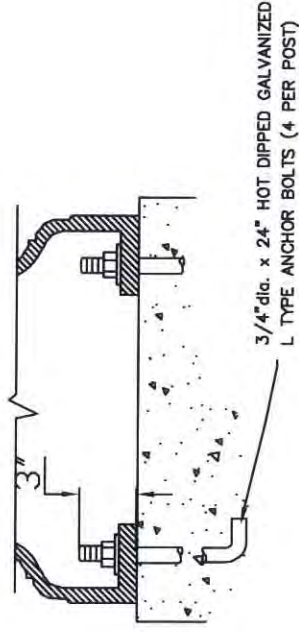
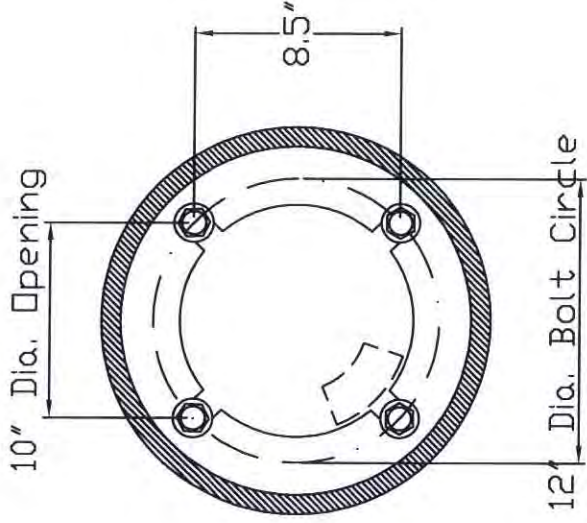

ANCHORAGE DETAIL

2 **TYPICAL LAMP POST & LUMINAIRE**

C1 SCALE: SCALE AS SHOWN

# NEWARK SERIES

Cat. # NK2-A-S40-H3-F-Q-DB-PR4/ARM-S-10-S-DB		Approvals
Job <b>Cemetery Street</b>	Type <b>S3</b>	

**SPAULDING  
LIGHTING**

### APPLICATIONS

- Provides superior lighting uniformity for parking areas, walkways, schools, and office parks.

### SPECIFICATIONS

- Formed and welded aluminum housing.
- Formed aluminum door with clear, flat tempered glass lens, fully gasketed to housing. Concealed hinge door secured with two captive screws.
- Specular, anodized aluminum reflectors for horizontal lamp, provide Type II, III, IV, or V square light patterns, and for vertical lamp provide Type IV or V square light patterns. Horizontal Type II and Type III reflectors with NK2, and vertical Type V5 reflector with NK2 with vertical lamp feature unique, micro-faceted designs. IESNA Full cutoff lighting classification achieved with flat lens.
- Extruded aluminum arm required for pole mount. Cast aluminum wall bracket available.
- Mogul porcelain socket, pulse rated, with spring-loaded, nickel-plated center contact and reinforced lamp grip screw shell. Medium base for ED-17 lamp.
- HPF ballast, starting rated at -20°C (-40°F for HPS).
- 100W-150W is LAG type HPF Ballast
- 175W-400W is CWA type HPF Ballast
- Durable Lektrocote® TGIC thermoset polyester powder coat paint finish assures long life and maintenance-free service.

### LISTINGS/CERTIFICATIONS

- UL 1598 listed and CSA certified for outdoor use in wet locations.
- IDA fixture seal of approval.

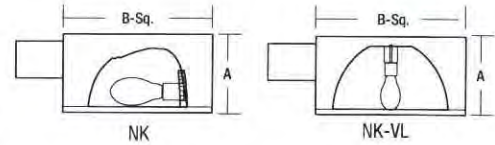

	A	B	EPA	Weight
<b>NK1</b>	8.0" 203 mm	14" 356 mm	0.9 ft. <sup>2</sup> 0.1 m <sup>2</sup>	33 lbs 15 kg
<b>NK2</b>	10" 254 mm	19" 483 mm	1.7 ft. <sup>2</sup> 0.2 m <sup>2</sup>	49 lbs 22.2 kg

NOTE: EPA and weight values do not include mounting arm

### ORDERING INFORMATION

ORDERING EXAMPLE: NK1-A-P15-H3-F-Q-DB-L

NK2	-	A	-	S40	-	H3	-	F	-	Q	-	DB	-	PR4
Series		Mounting		Wattage/ Source		Lamp Orientation/Distribution		Lens		Voltage		Color		Options

### SERIES

<b>NK1</b> Newark 1
(100-175W - H3, H4, H5) or (100-175W - V5)
<b>NK2</b> Newark 2
(150-400W - H2, H3, H4, H5) or (150-200W - V4, V5)

### MOUNT

<b>A</b> Arm Mount (arm not included, order separately)
---

### WATTAGE/SOURCE

PULSE START METAL HALIDE	
<b>P10</b>	100 watt (ED-17 med base) NK1 only
<b>P12</b>	125 watt (ED-17 med base) NK1 only
<b>P15</b>	150 watt (ED-28 mog base) NK1 only <sup>1</sup>
<b>P17</b>	175 watt (ED-17 med base) <sup>2</sup>
<b>P20</b>	200 watt NK2 only <sup>4</sup>
<b>P25</b>	250 watt (ED-28 mog base) NK2 only <sup>4</sup>
<b>P32</b>	320 watt (ED-28 mog base) NK2 only <sup>4</sup>
<b>P35</b>	350 watt (ED-28 mog base) NK2 only <sup>4</sup>
<b>P40</b>	400 watt (ED-28 mog base) NK2 only <sup>4</sup>

### WATTAGE/SOURCE con't

HIGH PRESSURE SODIUM	
<b>S10</b>	100 watt NK1 only <sup>1</sup>
<b>S15</b>	150 watt <sup>7</sup>
<b>S25</b>	250 watt (ED-28 mog base) NK2 only <sup>4</sup>
<b>S40</b>	400 watt (ED-28 mog base) NK2 only <sup>4</sup>

### LAMP ORIENTATION/DISTRIBUTION

<b>H2</b>	Horizontal II NK2 only <sup>4</sup>
<b>H3</b>	Horizontal III
<b>H4</b>	Horizontal IV
<b>H5</b>	Horizontal V (square)
<b>V4</b>	Vertical IV NK2 only
<b>V5</b>	Vertical V (square)

### LENS

<b>F</b> Flat
---------------

### VOLTAGE

<b>Q</b> Quad-Tap <sup>5</sup> - 120/208/240/277V <sup>4</sup>
<b>5</b> 480V <sup>6</sup>
<b>T</b> Tri-Tap <sup>5</sup> - 120/277/347V <sup>4</sup>

### COLOR

<b>DB</b>	Dark Bronze
<b>BL</b>	Black
<b>WH</b>	White
<b>GR</b>	Gray
<b>PS</b>	Platinum Silver
<b>RD</b>	Red (premium color)
<b>FG</b>	Forest Green (premium color)
<b>CC</b>	Custom Color (consult factory)

### OPTIONS

<b>F1</b>	Fusing - 120V
<b>F2</b>	Fusing - 208V
<b>F3</b>	Fusing - 240V
<b>F4</b>	Fusing - 277V
<b>F5</b>	Fusing - 480V
<b>F6</b>	Fusing - 347V
<b>P1</b>	Photo Button - 120V
<b>P2</b>	Photo Button - 208V
<b>P3</b>	Photo Button - 240V
<b>P4</b>	Photo Button - 277V
<b>P6</b>	Photo Button - 347V
<b>PR1</b>	Photo Cell Receptacle - 120V
<b>PR2</b>	Photo Cell Receptacle - 208V
<b>PR3</b>	Photo Cell Receptacle - 240V
<b>PR4</b>	Photo Cell Receptacle - 277V
<b>PR5</b>	Photo Cell Receptacle - 480V
<b>PR6</b>	Photo Cell Receptacle - 347V
<b>QZ</b>	Quartz Restrike with lamp
<b>HS</b>	Internal House-Side Shield <sup>8</sup>
<b>RP</b>	Removable Powr-Panl <sup>8</sup>
<b>VG</b>	Polycarbonate Vandal Guard
<b>L</b>	Lamp

<sup>1</sup> BD-17 medium base in vertical position, T15 mogul base in horizontal position  
<sup>2</sup> Vertical orientation only.  
<sup>3</sup> Available in NK2 only.  
<sup>4</sup> Factory wired for highest voltage unless specified.  
<sup>5</sup> Not available with 100w Pulse Start MH lamp.  
<sup>6</sup> Horizontal lamp only  
<sup>7</sup> BD-17 medium base in vertical position, T15 mogul base in horizontal position



## ORDERING INFORMATION

ORDERING EXAMPLE ARM: ARM-S-6-S-DB

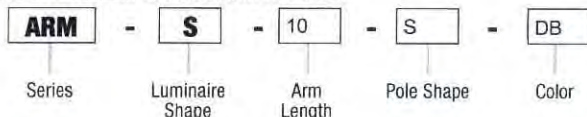

### SERIES

**ARM** Rigid Arm

### LUMINAIRE SHAPE

**S** Square/Rectangular

### ARM LENGTH

**6** 6" Arm (EPA=0.24 ft<sup>2</sup>, 3.5 lbs)  
(0.02 m<sup>2</sup>, 1.5 kg)

**10** 10" Arm (EPA=0.4 ft<sup>2</sup>, 5.0 lbs)  
(0.03 m<sup>2</sup>, 2.2 kg)<sup>1</sup>

### POLE SHAPE

#### #1 DRILL PATTERN FOR POLE

**S** Square

**R4** Round Straight (4.5")

**R5** Round Straight (5")

**R6** Round Straight (6")

#### #2 DRILL PATTERN FOR POLE

**T2** Round Tapered (2.5")

**T3** Round Tapered (3")

**T35** Round Tapered (3.5")

**T4** Round Tapered & Straight (4")

### COLOR

**DB** Dark Bronze

**BL** Black

**WH** White

**GR** Gray

**PS** Platinum Silver

**RD** Red (premium color)

**FG** Forest Green (premium color)

**CC** Custom Color (consult factory)

<sup>1</sup> Required for 90° configurations

### WALL BRACKET

**WB-S-XX** Bracket only, arm not included nor required for fixture mounting  
Replace **XX** with color designation

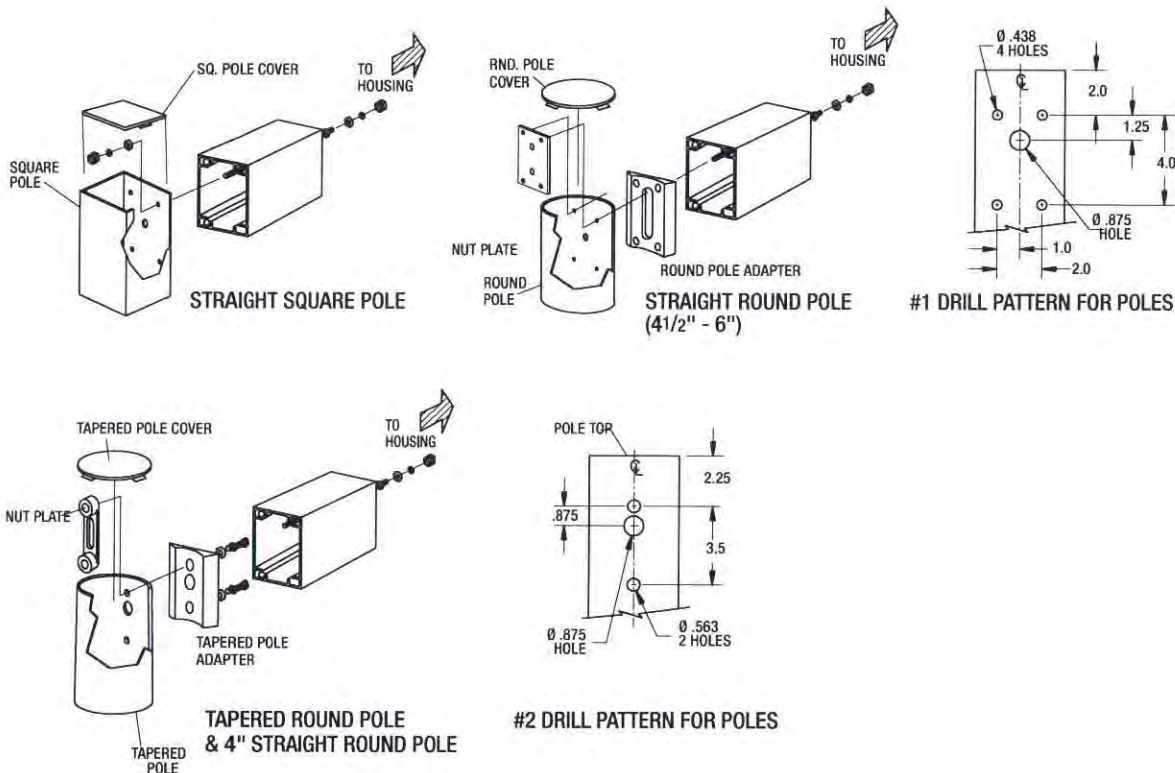

Due to our continued efforts to improve our products, product specifications are subject to change without notice.

**SPAULDING**  
**LIGHTING**

Spaulding Lighting • 701 Millennium Drive • Greenville, SC 29607 • PHONE: 864-678-1000  
For more information visit our web site: [www.spauldinglighting.com](http://www.spauldinglighting.com)

## ACCESSORIES

### POLE ADAPTERS

<b>RPA4-XX</b>	Round pole adapter for (4.5" round straight dia. pole)
<b>RPA5-XX</b>	Round pole adapter for (5 to 6" round straight dia. pole)
<b>RTPA2.5-XX</b>	Round pole adapter for (2-3/8" to 2-5/8" round tapered dia. pole)
<b>RTPA3-XX</b>	Round pole adapter for (2-3/4" to 3-1/8" round tapered dia. pole)
<b>RTPA3.5-XX</b>	Round pole adapter for (3-1/4" to 3-3/4" round tapered dia. pole)
<b>RTPA4-XX</b>	Round pole adapter for (3-7/8" to 4" round tapered dia. pole)
<b>AASF</b>	Tenon arm, (single) adjustable
<b>AADM</b>	Adjustable arm for flat surfaces
<b>FEA-2-XX</b>	Triangle steel adapt double @ 120 deg.
<b>FEA-3-XX</b>	Triangle steel adapt triple @ 120 deg.
<b>2-SA-SGL-D-XX</b>	Square steel adapt single
<b>2-SA-D90-XX</b>	Square steel adapt-double @ 90 deg.
<b>2-SA-D180-XX</b>	Square steel adapt-double @ 180 deg.
<b>2-SA-TPL-D90-XX</b>	Square steel adapt-triple @ 90 deg.
<b>2-SA-QD-D-XX</b>	Square steel adapt-quad @ 90 deg.
<b>2-RA-SGL-D-XX</b>	Round steel adapt-single
<b>2-RA-D90-XX</b>	Round steel adapt-double @ 90 deg.
<b>2-RA-D180-XX</b>	Round steel adapt-double @ 180 deg.
<b>2-RA-TPL-D90-XX</b>	Round steel adapt-triple @ 90 deg.
<b>2-RA-TPL-D120-XX</b>	Round steel adapt-triple @ 120 deg.
<b>2-RA-QD-D-XX</b>	Round steel adapt-triple @ 90 deg.
<b>MAF-XX</b>	Horizontal mast arm fitter for 2-3/8" OD mast arm
<b>CBL-2-XX</b>	Twin parallel luminaire bracket
<b>8914556</b>	NK1 Internal, house side sheild, Type III, IV, V
<b>93001585</b>	NK2 Internal, house side sheild, Type II, III, IV, V
<b>PTL-1</b>	(must use PCR (X) option) Photocontrol - Twistlock cell (120V)
<b>PTL-8</b>	(must use PCR (X) option) Photocontrol - Twistlock cell (120, 208, 240, 277V)
<b>PTL-5</b>	(must use PCR (X) option) Photocontrol - Twistlock cell (480V)
<b>PTL-6</b>	(must use PCR (X) option) Photocontrol - Twistlock cell (347V)
<b>PSC</b>	(must use PCR (X) option) Shorting Cap - Twistlock

Due to our continued efforts to improve our products, product specifications are subject to change without notice.



Spaulding Lighting • 701 Millennium Drive • Greenville, SC 29607 • PHONE: 864-678-1000  
For more information visit our web site: [www.spauldinglighting.com](http://www.spauldinglighting.com)

# SQUARE STRAIGHT ALUMINUM POLES

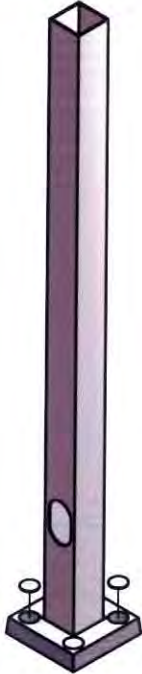

## Pole Shaft Specifications

The shaft is extruded from all new 6063 alloy aluminum tubing and heat treated to produce a T6 temper. The standards may be drilled to accept side arm mounted luminaires. Advise mounting orientation. An aluminum tenon may also be supplied as standard.

## Anchor Base

Cast from A356 alloy aluminum, the anchor base shall be heat treated to produce a T6 condition. The shaft shall be inserted into the anchor base casting. The anchor base casting and shaft shall be joined by a continuous circumferential weld at the outside top and inside bottom of the anchor base. The anchor bolt and nut recesses in the anchor base casting and shall be flush covered by four (4) tamper-resistant aluminum nut cover discs.

## SQUARE STRAIGHT ALUMINUM POLES

Catalog Number	Mtg. Ht. (ft.)	*Effective Projected Area (sq. ft.)				Shaft Dimensions		Base Information (in.)		Base Plate (in.) (L x W x H)
		80	90	100	120	Sq. Size (in.)	Wall Thick.	Anchor Bolt Dia.	Bolt Circle	
CPA-1-4012-8	8	13.8	10.8	8.4	7.3	4	.125	.75 x 20	8.5	9.13 x 9.13 x 2.0
CPA-1-4012-10	10	10.6	8.3	6.3	4.5	4	.125	.75 x 20	8.5	9.13 x 9.13 x 2.0
CPA-1-4012-12	12	8.4	6.5	4.8	2.6	4	.125	.75 x 20	8.5	9.13 x 9.13 x 2.0
CPA-1-4012-14	14	6.8	5.1	3.7	1.5	4	.125	.75 x 20	8.5	9.13 x 9.13 x 2.0
CPA-1-4012-15	15	6.1	4.5	3.2	0.9	4	.125	.75 x 20	8.5	9.13 x 9.13 x 2.0
CPA-1-4012-16	16	5.5	4.0	2.8	—	4	.125	.75 x 20	8.5	9.13 x 9.13 x 2.0
CPA-1-4018-16	16	8.9	6.8	5.0	2.1	4	.188	.75 x 20	8.5	9.13 x 9.13 x 2.0
CPA-1-4012-18	18	4.4	3.1	2.1	—	4	.125	.75 x 20	8.5	9.13 x 9.13 x 2.0
CPA-1-4018-18	18	7.5	5.6	4.0	1.0	4	.188	.75 x 20	8.5	9.13 x 9.13 x 2.0
CPA-1-5018-18	18	12.6	9.6	7.1	2.9	5	.188	.75 x 20	10.5	10.44 x 10.44 x 2.5
CPA-1-4018-20	20	6.3	4.6	3.2	1.0	4	.188	.75 x 20	8.5	9.13 x 9.13 x 2.0
CPA-1-5018-20	20	10.8	8.1	5.8	1.5	5	.188	.75 x 20	10.5	10.44 x 10.44 x 2.5
CPA-1-6018-20	20	16.4	12.4	9.2	3.8	6	.188	1 x 40	12.0	11.96 x 11.96 x 2.75
CPA-1-6025-20	20	22.6	17.4	13.1	6.8	6	.250	1 x 40	12.0	11.96 x 11.96 x 2.75
CPA-1-5018-25	25	7.3	5.1	3.3	1.0	5	.188	.75 x 20	10.5	10.44 x 10.44 x 2.5
CPA-1-6018-25	25	11.6	8.4	5.8	2.0	6	.188	1 x 40	12.0	11.96 x 11.96 x 2.75
CPA-1-6025-25	25	16.5	12.3	8.9	2.2	6	.250	1 x 40	12.0	11.96 x 11.96 x 2.75
▲ CPA-1-6018-30	30	8.0	5.4	3.2	—	6	.188	1 x 40	12.0	11.96 x 11.96 x 2.75
▲ CPA-1-6025-30	30	12.1	8.7	5.8	2.0	6	.250	1 x 40	12.0	11.96 x 11.96 x 2.75

\* EPA ratings include a 1.3 gust factor.

▲ Vibration dampeners are suggested for poles 30 feet and above.

● Anchor Bolts should be set using factory supplied anchor bolt templates.



## English Edge® Series

English Edge® is the ultimate in interlocking pavers for sand-based applications. Sizes: 2 1/4" x 4" x 8" pedestrian/light vehicular and 2 3/4" x 4" x 8" heavy vehicular. Made from hardened Triassic shale, this paver features beveled edges on both bed surfaces making it easy to install and to flip over should the need arise. Spacer nibs provide consistent joints with virtually no edge chippage even on driveways. Elegant and prestigious, any English Edge® color you choose will last a lifetime. All our pavers exceed the most stringent ASTM standards with high strength (10,000 psi+) and low water absorption (5-6%).



English Edge® Full Range

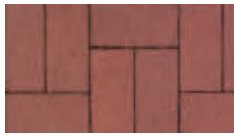

English Edge® Red

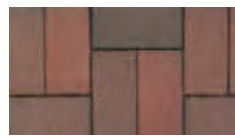

English Edge® Autumn

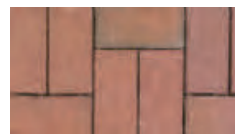

English Edge® Rose



English Edge® Cocoa Full Range



English Edge® Dark Accent



English Edge® Ironspot

## Traditional Series

Square edge pavers offer the classic brick look at an attractive price. Square edge pavers can be laid in sand or mortar and are made to stand the test of time. All our pavers exceed the most stringent ASTM standards with high strength (10,000 psi+) and low water absorption (5-6%). Size: 2 1/4" x 4" x 8" pedestrian/light vehicular.



Pathway Full Range



Pathway Red



Pathway Full Range

# Hanover® Detectable Warning® Paver

Persons with visual impairments depend upon environmental cues of potential hazards — ambient sounds and physical elements that can be sensed by a cane or texture changes underfoot. Any pedestrian area requiring the use of a detectable warning surface can utilize the Detectable Warning® Paver. The distinctively textured walking surface can help to warn pedestrians of an impending hazard on the route ahead.

Stocked Sizes	Stocked Colors
1 13/4" x 1 13/4" x 2" (297mm x 297mm x 51mm)	Red 15
2 3 1/2" x 2 3 1/2" x 2" (597mm x 597mm x 51mm)	Charcoal Yellow (M1517)
Please Note: Other sizes and colors are available upon request when quantities permit. Contact a Hanover® Representative for more information.	

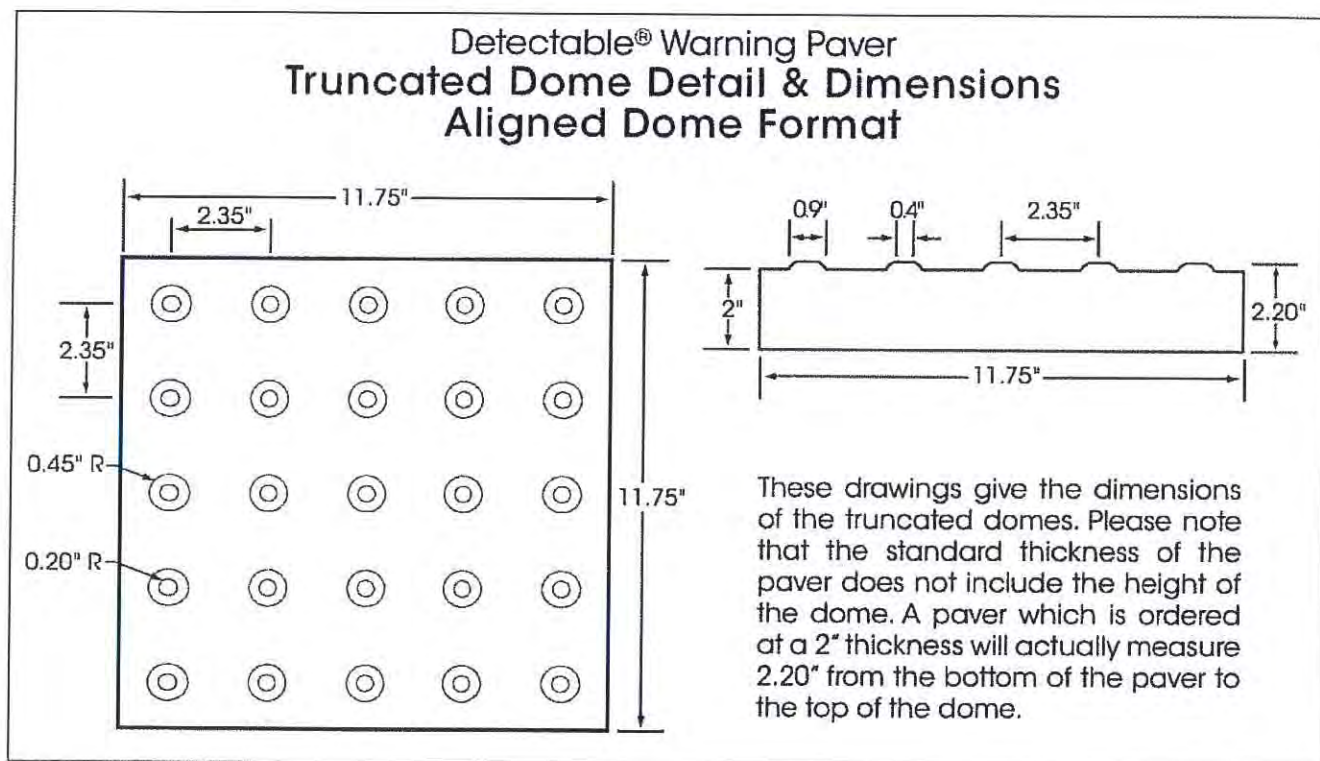

## HANOVER®

**Architectural Products**

5000 Hanover Road, Hanover, PA 17331

717.637.0500 fax 717.637.7145

www.hanoverpavers.com



# ADA Paver™ Colors

Charcoal

[Back to ADA Paver™ main page](#)

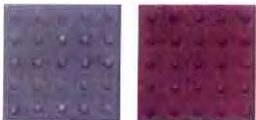
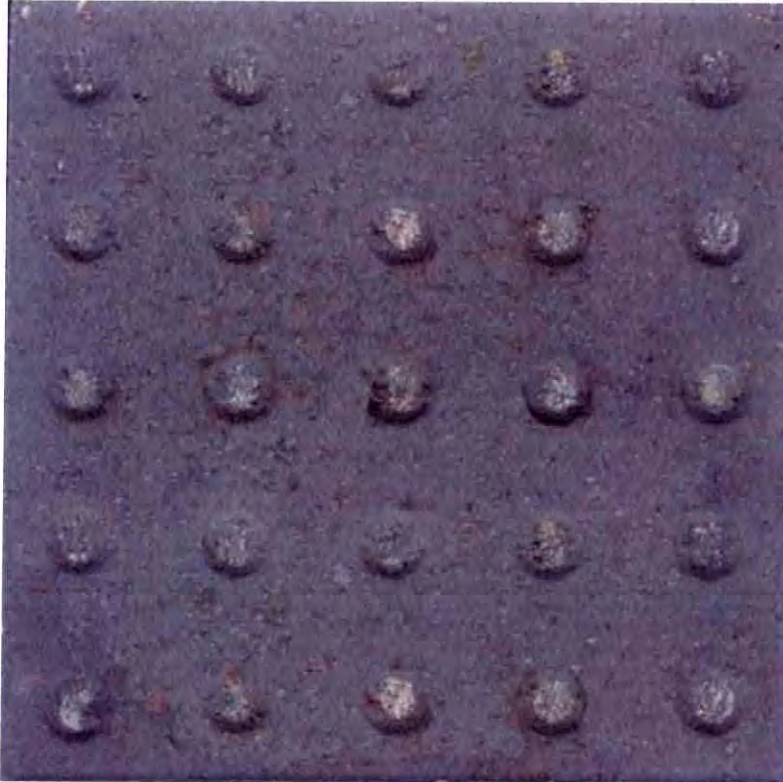

Colors, product data, and availability are subject to change without notice. Please confirm all details with your local Unilock Dealer or call 1-800-UNILOCK. The colors shown should only be used as a guide. Final color selections should always be made from actual samples.

# Chain link Fencing

